

**HEAVY
BELT**



Cinghie, pulegge e tenditori.

**Belts, pulleys and tensioners.
Courroies, poulies et tendeurs.
Correas, poleas y tensores.
Riemen, Riemenscheiben und Spanner.**



ITA

La sottoscritta Agenzia 490 S. LAZZARO della compagnia di assicurazioni: REAL MUTUA ASSICURAZIONI;

DICHIARA

che la ditta LE.MA S.r.l. - Trucks and Buses Spare Parts con sede in Bologna, Via del Vetraio 26, è assicurata per la Responsabilità Civile "Prodotti" verso Terzi con polizza n. 2016/03/2268436 avente le seguenti caratteristiche:

Massimale: € 2.000.000,00

Validità territoriale: Mondo intero (USA, Canada e Messico)

Prodotti assicurati: parti di ricambio per autoveicoli

Le Condizioni Generali e Particolari sono stabilite dalla Polizza di Assicurazione della Responsabilità Civile verso Terzi "Prodotti" dell'ANIA - Associazione Nazionale fra le Imprese Assicuratrici

ENG

The undersigned Agency 490 S. LAZZARO of the insurance company: REAL MUTUA ASSICURAZIONI;

DECLARES

that the company LE.MA S.r.l. - Trucks and Buses Spare Parts located in Bologna, Via del Vetraio 26, insured itself for Civil Liability towards third-parties, by the contract n. 01267600 having the following conditions:

Maximum refund: € 2.000.000,00

Territory of validity: Worldwide (USA, Canada and Mexico)

Products covered by insurance: spare parts for vehicles

The General and Specific Conditions of this contract are included in the Insurance Contract for Civil Liability towards third-parties, stated by ANIA - Insurance Companies National Association.

CERTIFICATO DI SISTEMA DI GESTIONE

Certificato n.:
50651-2009-AQ-ITA-SINCERT

Data Prima Emissione:
30 marzo 2009

Validità:
31 marzo 2024 – 30 marzo 2027

Si certifica che il sistema di gestione di

DUBHE S.r.l.

Via Sestriere, 3 - 10060 Candiolo (TO) - Italia

e i siti come elencati nell'Appendice che accompagna questo certificato

È conforme allo Standard:

ISO 9001:2015

Questa certificazione è valida per il seguente campo applicativo:

**Commercializzazione di motori originali per mezzi di trasporto per persone, merci e altro.
Commercializzazione di ricambi originali e non, a marchio proprio di parti di motore per
mezzi di trasporto per persone, merci e altro. Fabbricazione e commercializzazione di
ricambi per autocarri ed autobus
(IAF 29, 22, 18)**

Luogo e Data:
Vimercate (MB), 03 aprile 2025



SGQ N° 003 A
SGA N° 003 D
SGE N° 007 M
SCR N° 004 F

EMAS N° 009 P
PRD N° 003 B
PRS N° 094 C
SSI N° 002 G

Membro di MLA EA per gli schemi di accreditamento
SGQ, SGA, PRD, PRS, ISP, GHG, LAB e LAT, di MLA IAF
per gli schemi di accreditamento SGQ, SGA, SSI, FSM
e PRD e di MRA ILAC per gli schemi di accreditamento
LAB, MED, LAT e ISP

Per l'Organismo di Certificazione:
DNV - Business Assurance
Via Energy Park, 14, - 20871 Vimercate (MB) -
Italy



Claudia Baroncini
Management Representative

MANAGEMENT SYSTEM CERTIFICATE

Certificate no.:
50651-2009-AQ-ITA-SINCERT

Initial certification date:
30 March 2009

Valid:
31 March 2024 – 30 March 2027

This is to certify that the management system of

DUBHE S.r.l.

Via Sestriere, 3 - 10060 Candiolo (TO) - Italy

and the sites as mentioned in the appendix accompanying this certificate

has been found to conform to the Quality Management System standard:

ISO 9001:2015

This certificate is valid for the following scope:

Sales of original engines for vehicles for transport of persons, goods and other. Sales of original spare parts and non original spare parts under own brand for engines for vehicles for transport of persons, goods and other. Manufacture and trade of trucks and buses spare parts (IAF 29, 22, 18)

Place and date:
Vimercate (MB), 03 April 2025



SGQ N° 003 A
SGA N° 003 D
SGE N° 007 M
SCR N° 004 F

EMAS N° 009 P
PRD N° 003 B
PRS N° 094 C
SSI N° 002 G

Membro di MLA EA per gli schemi di accreditamento SGQ, SGA, PRD, PRS, ISP, GIG, LAB e LAT, di MLA IAF per gli schemi di accreditamento SGQ, SGA, SSI, FSM e PRD e di MRA ILAC per gli schemi di accreditamento LAB, MED, LAT e ISP

For the issuing office:
DNV - Business Assurance
Via Energy Park, 14, - 20871 Vimercate (MB) - Italy



Claudia Baroncini
Management Representative

ITA

Il marchio **Heavybelt** (HB) è stato fondato nel 2020, dando il via a un processo di ricerca e sviluppo dedicato alle nuove linee di prodotto che rivestono un ruolo centrale nella manutenzione straordinaria dei veicoli. Tra queste, spiccano le cinghie, i tenditori e le pulegge.

Heavybelt (HB) è un marchio private label distribuito da Dubhe Srl.

Dubhe è il distributore italiano specializzato in parti di ricambio per autocarro, veicolo commerciale, bus e rimorchio, con una forte specializzazione sui ricambi motore, cambio e differenziale.

Con oltre 50 anni di esperienza, il gruppo Dubhe offre ai propri clienti una vasta gamma di prodotti sia con marchio proprio che premium.

Grazie all'ampia conoscenza tecnica, produttiva e commerciale delle aziende fondatrici, (Mec-Diesel S.r.l., C.E.I. Costruzione Emiliana Ingranaggi S.p.A. e Lema S.r.l.), Dubhe garantisce elevati standard qualitativi.

ENG

The **Heavybelt** (HB) brand was established in 2020, initiating a research and development process for new product lines that play a central role in the extraordinary maintenance of vehicles. Among these, there are belts, tensioners, and pulleys.

Heavybelt (HB) is a private label distributed by Dubhe Srl.

Dubhe is the Italian distributor specialised in spare parts for trucks, commercial vehicles, buses and trailers, with a strong focus on engines, gearboxes, differentials and their components.

With over 50-years history, Dubhe Group offers a wide product range under private labels and premium brands.

Thanks to the technical, production and commercial knowledge of the founding companies, (Mec-Diesel S.r.l., C.E.I. Construction Emiliana Ingranaggi S.p.A. and Lema S.r.l.), Dubhe ensures high quality standards.

Indice sezioni.
Section index

Sezione A Section A	Tenditori e pulegge Introduzione tecnica <i>Tensioners and pulleys Technical introduction</i>	.5
	Tenditori e pulegge Elenco codici HEAVYBELTS <i>Tensioners and pulleys HEAVYBELTS items list</i>	.11
Sezione B Section B	Cinghie trasmissione Introduzione tecnica <i>Transmission belts Technical introduction</i>	.47
	Cinghie trasmissione Elenco codici tipologia AVX-XPB <i>Transmission belts AVX-XPB type items list</i>	.53
	Cinghie trasmissione Elenco codici tipologia PK <i>Transmission belts PK type items list</i>	.77
Sezione C Section C	Kit Distribuzione e Ausiliari <i>Timing and accessory kits</i>	.91
Sezione D Section D	Tenditori e pulegge Indice per applicazione <i>Tensioners and pulleys Index by application</i>	.99



**Tenditori e pulegge
Tensioners and pulleys.**

*Per applicazione bus, veicoli commerciali leggeri e pesanti
Suitable for bus, LCV and HDV applications.*

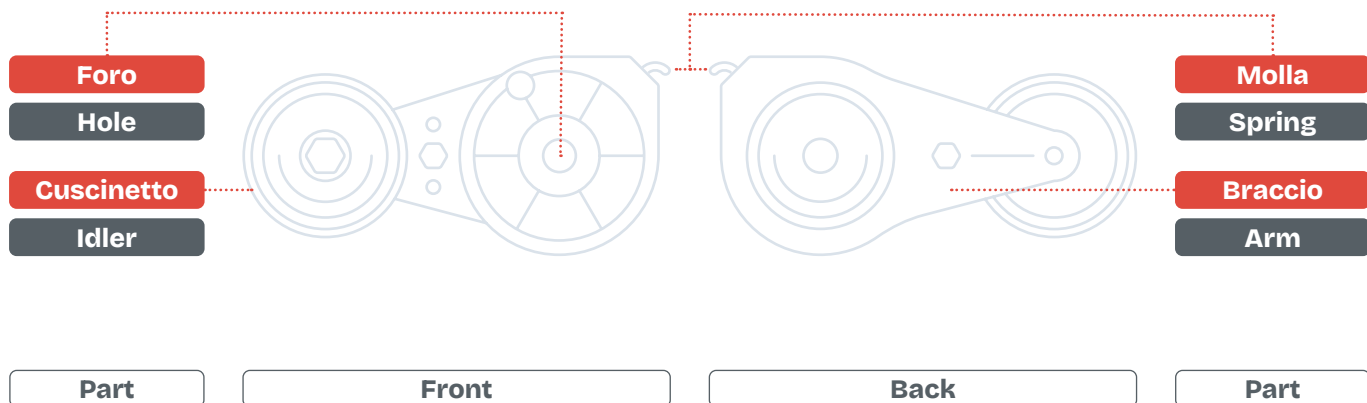
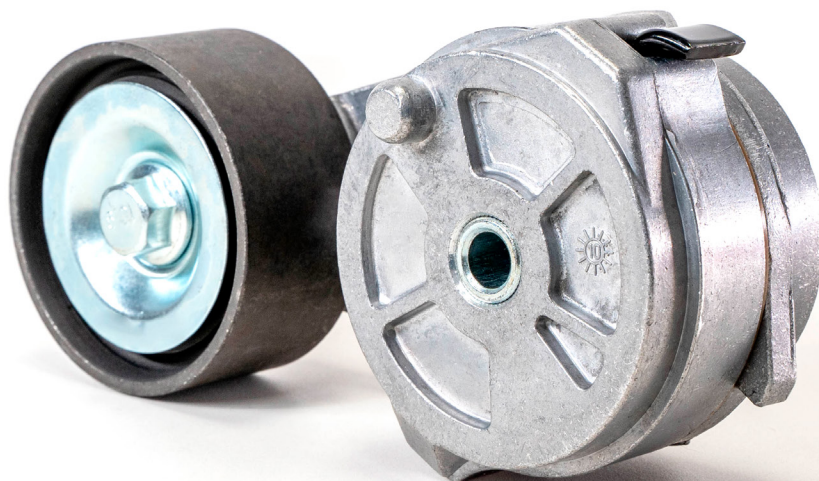

INFO TECNICHE TECHNICAL INFO.

I tendicinghia sono i componenti che, agendo direttamente a contatto della cinghia, provvedono a garantirne la corretta tensione durante l'utilizzo, sia essa per scopi di distribuzione che ausiliari. I prodotti trattati possono essere suddivisi in due categorie: **tendicinghia** e **cuscinetti di rimando** (o galoppini).

Tensioners are the components that, by directly interacting with the belt, ensure their proper tension during use, both for distribution and auxiliary purposes. The treated products can be classified into two categories: tensioners and idler pulleys.

TENDICINGHIA

Lunghezza: viene indicata con la lettera [L]
Length: is made by the letter [L]

Spessore: viene indicato con la lettera [H2]
Height/Thickness: is made by the letter [H2]

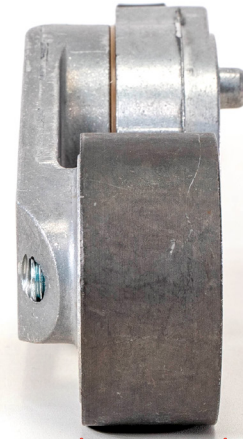
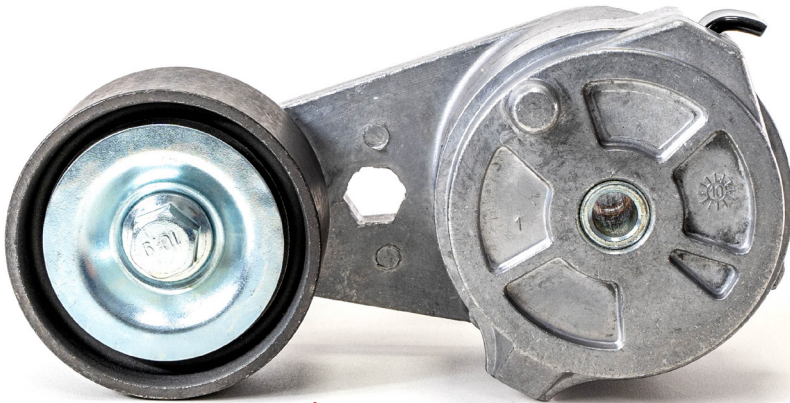

Diametro: viene indicato con il simbolo [Ø]
Diameter: is made by the sign [Ø]

Spessore: viene indicato con la lettera [H1]
Height/Thickness: is made by the letter [H1]

TENDICINGHIA

I tendicinghia, che costituiscono la categoria più completa e complessa, sono generalmente composti da una base di supporto fissata solidamente al monoblocco tramite bulloni passanti. La base include un cuscinetto su cui scorre la cinghia e un braccio tenditore. Questo braccio, attraverso un meccanismo che può essere di tipo meccanico, a molla o idraulico, esercita tensione sulla cinghia tramite il cuscinetto.

TENSIONERS

Tensioners, representing the most comprehensive and complex category, are typically composed of a support base firmly connected to the engine block through passing bolts. The base includes an idler pulley on which the belt slides, and a tensioning arm. This arm, through a mechanism that can be mechanical, spring-loaded, or hydraulic, applies tension to the belt through the idler pulley.

SEGNI DI USURA SIGNS OF WEAR.

- Rumorosità o battito causati dalla mancanza di tensione (*molla scarica, pistone idraulico scarico, passaggi dell'olio otturati*);
- Rottura della molla tenditrice a seguito di vibrazioni eccessive della cinghia derivanti da fattori esterni;
- Disallineamento della base con il braccio tenditore a causa della rottura o perdita di tensione della molla interna.
- *Noise or knocking caused by lack of tension (depleted spring, discharged hydraulic piston, blocked oil passages);*
- *Breaking of the tensioning spring due to excessive belt vibrations derived from external factors;*
- *Misalignment of the base with the tensioning arm due to the breaking or loss of tension in the internal spring.*

TENSIONER MARKING EXAMPLE



BRAND CODE PROD. (MM/YY)



Fig. 1

TENDICINGHIA

La scelta più comune tra i costruttori ricade sui tendicinghia a molla, che offrono un ottimo equilibrio tra vantaggi tecnici e costruttivi, senza compromettere la qualità e la durabilità del prodotto stesso.

L'evoluzione tecnica di questa categoria di prodotti ha portato a vantaggi sempre maggiori. Di seguito, i principali:

- Facilità di installazione e smontaggio della cinghia;
- Tensione costante corretta in qualsiasi situazione di utilizzo;
- Smorzamento delle vibrazioni trasmesse dalla cinghia (*applicabile solo a sistemi di tensione mobili come molla o idraulici*);
- Manutenzione ridotta al minimo grazie alla capacità dei tendicinghia di compensare il naturale allungamento della cinghia nel tempo;
- Facilità di sostituzione in caso di problemi.

Un accenno particolare va fatto ai tendicinghia o tendicatena idraulici (Fig. 1), che svolgono la stessa funzione ma sono azionati da un piccolo ammortizzatore installato sul gruppo tenditore o direttamente dalla pressione dell'olio motore.

TENSIONERS

The most common choice among manufacturers is spring-loaded tensioners. They offer an excellent balance between technical and construction advantages without compromising quality and durability.

The technical evolution of this product category has led to increasingly significant benefits. Below, the main ones:

- Ease of belt installation and removal;
- Consistently correct tension in any usage scenario;
- Vibration damping transmitted by the belt (*applicable only to mobile tension systems such as spring or hydraulic*);
- Minimal maintenance thanks to the tensioners ability to compensate for the natural belt elongation over time;
- Ease of replacement in case of issues.

A particular mention should be made of hydraulic tensioners or chain tensioners (Fig. 2), which perform the same type of work but are actuated by a small damper installed on the tensioner assembly or directly by the engine oil pressure.

CUSCINETTI



Diametro: viene indicato con il simbolo [\varnothing]
Diameter: is made by the sign [\varnothing]

Spessore: viene indicato con la lettera [H]
Height/Thickness: is made by the letter [H]

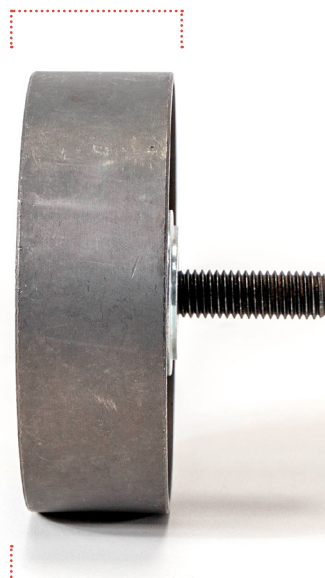

Lunghezza: viene indicata con la lettera [L]
Length: is made by the letter [L]

CUSCINETTI DI RIMANDO

I cuscinetti di rimando, comunemente chiamati galoppini (per analogia di utilizzo con la parola francese *galopin*, che significa messaggero), consistono in una puleggia installata su un cuscinetto, volta a deviare il tratto non tensionato della cinghia per garantirne maggiore aderenza durante la rotazione. Sia i cuscinetti montati sui tendicinghia che i galoppini possono essere realizzati in materiale plastico, acciaio zincato o, più raramente, in alluminio.

IDLER PULLEYS

The idler pulleys consist of a pulley installed on a bearing. They are designed to redirect the slack portion of the belt to ensure greater grip during rotation.

Both the bearings mounted on the tensioners and the idler pulleys can be made of plastic, galvanized steel, or, more rarely, aluminum.

SEGNI DI USURA SIGNS OF WEAR.

- Rumorosità o stridio causati dal consumo del cuscinetto interno al rullo;
- Scioglimento del materiale del rullo (applicabile solo ai rulli in materiale plastico) causato da un innalzamento anomalo delle temperature del monoblocco o dal grippaggio del cuscinetto interno;
- Rotazione fuori asse causata dal consumo del cuscinetto interno al rullo.
- Noise or squeaking caused by the wear of the internal bearing in the roller;
- Melting of the roller material (only applicable to plastic rollers) due to abnormal temperature increase in the crankcase or seizing of the internal bearing;
- Off-center rotation caused by the wear of the internal bearing in the roller.

Suitable for **CITROEN**

Adatto a **CITROEN**

HB233

Cross Ref:

082965 [CITROEN]

Suitable for:

8140
JUMPER - [2.5 - 2.8 CC]

Details:

Rullo tenditore
Puleggia in metallo
Tensioner pulley
Metal pulley
L: 92.0mm | Ø: 21.0mm

Ø: 21.0mm

L: 92.0mm

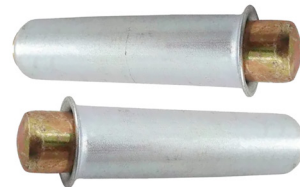

HB235

Cross Ref:

81832 [CITROEN]

Suitable for:

JUMPER - [2.5 CC]

Details:

Tendicinghia
Puleggia in metallo
Belt tensioner
Metal pulley
H: 37.0mm | Ø: 64.0mm

Ø: 64.0mm

H: 37.0mm

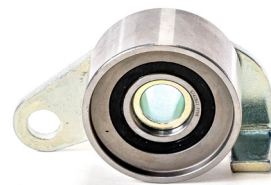

HB236

Cross Ref:

00818.32 [CITROEN]

Suitable for:

8140
JUMPER - [2.5 CC]

Details:

Tendicinghia
Puleggia in metallo
Belt tensioner
Metal pulley
H: 34.0mm | Ø: 67.0mm

Ø: 67.0mm

H: 34.0mm



Adatto a **CUMMINS**

Suitable for **CUMMINS**

Ø: 85.2mm

H: 32.0mm

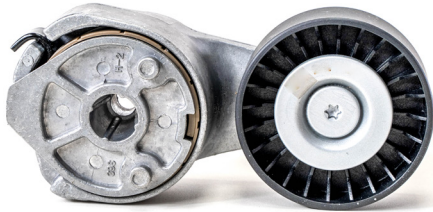

HB232

Cross Ref:

4987964 [CUMMINS]

Suitable for:

EUROCARGO I>V 100/120/150E - [4.5 - 5.9 - 6.7 CC]

Details:

Tendicinghia

Puleggia in metallo

Belt tensioner

Metal pulley

L: 53.5mm | H: 32.0mm | Ø: 85.2mm

Suitable for **DAF**

Adatto a **DAF**

HB214

Cross Ref:

1399613 [DAF]

Suitable for:

CF65 - [3.9 - 5.9 CC]

Details:

Galoppino/guidacinghia

Puleggia in metallo

Deflection/Guide pulley

Metal pulley

H: 32.0mm | Ø: 65.0mm

Ø: 65.0mm

H: 32.0mm



HB218

Cross Ref:

1702527 [DAF]

Suitable for:

CF65 - [3.9 - 5.9 CC]

Details:

Galoppino/guidacinghia

Puleggia in metallo

Deflection/Guide pulley

Metal pulley

H: 32.0mm | Ø: 65.0mm

Ø: 65.0mm

H: 32.0mm



HB223

Cross Ref:

1699030 [DAF]

Suitable for:

PE/PR183/XE250

CF SERIES - [9.2 - 12.6 CC]

Details:

Galoppino/guidacinghia

Puleggia in metallo

Deflection/Guide pulley

Metal pulley

H: 32.0mm | Ø: 90.0mm

Ø: 90.0mm

H: 32.0mm



Adatto a **DAF**

Suitable for **DAF**

Ø: 75.1mm

H: 40.1mm



HB230

Cross Ref:

1653584 [DAF]

Suitable for:

XF 105 - CF85 - [12.9 CC]

Details:

Tendicinghia

Puleggia in metallo

Belt tensioner

Metal pulley

L: 118.3mm | H: 40.1mm | Ø: 75.1mm

Ø: 85.2mm

H: 32.0mm

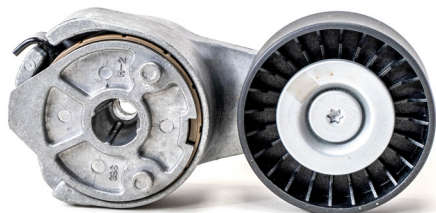

HB232

Cross Ref:

1399691 [DAF]

Suitable for:

LF 45/CF 65 - [4.5 - 5.9 - 6.7 CC]

Details:

Tendicinghia

Puleggia in metallo

Belt tensioner

Metal pulley

L: 53.5mm | H: 32.0mm | Ø: 85.2mm

Ø: 78.0mm

H: 38.6mm



HB294

Cross Ref:

1458924 [DAF]

Suitable for:

XF 105/CF85 - [12.9 CC]

Details:

Galoppino/guidacinghia

Puleggia in metallo

Deflection/Guide pulley

Metal pulley

H: 38.6mm | Ø: 78.0mm

Suitable for **DAF**

Adatto a **DAF**

HB298

Cross Ref:

1627625 [DAF]

Suitable for:

XF 105/CF85 - [12.9 CC]

Details:

Tendicinghia

Puleggia in metallo

Belt tensioner

Metal pulley

L: 73.0mm | H: 31.2mm | Ø: 69.9mm

Ø: 69.9mm

H: 31.2mm



HB350

Cross Ref:

1398620 [DAF]

Suitable for:

XE250/280/315

CF/XF/YTZ SERIES - [12.6 CC]

Details:

Tendicinghia

Puleggia in metallo

Belt tensioner

Metal pulley

L: 103.0mm | H: 32.5mm | Ø: 77.0mm

Ø: 77.0mm

H: 32.5mm



Adatto a **EVOBUS**

Suitable for **EVOBUS**

Ø: 80.0mm

H: 45.0mm



HB254

Cross Ref:

A5412002570 [EVOBUS]

Suitable for:

TOURISMO - [12.0 - 16.0 CC]

Details:

Tendicinghia

Puleggia in metallo

Belt tensioner

Metal pulley

L: 68.0mm | H: 45.0mm | Ø: 80.0mm

Suitable for **FIAT**

Adatto a **FIAT**

HB233

Cross Ref:

4279745 [FIAT]

Suitable for:

8140/8144
DUCATO - [2.5 - 2.8 CC]

Details:

Rullo tenditore
Puleggia in metallo
Tensioner pulley
Metal pulley
L: 92.0mm | Ø: 21.0mm

Ø: 21.0mm

L: 92.0mm

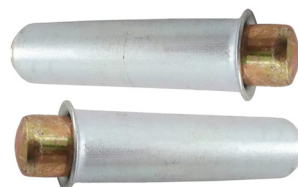

HB235

Cross Ref:

7301661 [FIAT]

Suitable for:

8140/8144
DUCATO - [2.5 CC]

Details:

Tendicinghia
Puleggia in metallo
Belt tensioner
Metal pulley
H: 37.0mm | Ø: 64.0mm

Ø: 64.0mm

H: 37.0mm

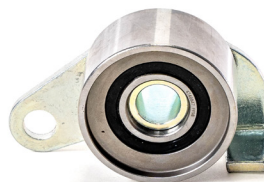

HB236

Cross Ref:

4740846 [FIAT]

Suitable for:

8140
DUCATO - [2.5 CC]

Details:

Tendicinghia
Puleggia in metallo
Belt tensioner
Metal pulley
H: 34.0mm | Ø: 67.0mm

Ø: 67.0mm

H: 34.0mm



Adatto a **FIAT**

Suitable for **FIAT**

Ø: 63.5mm

H: 34.0mm



HB310

Cross Ref:

7301662 [FIAT]

Suitable for:

8140.43

DUCATO - [2.5 - 2.8 CC]

Details:

Galoppino/Guidacinghia

Puleggia in metallo

Deflection/Guide pulley

Metal pulley

H: 34.0mm | Ø: 63.5mm

Suitable for **FORD**

Adatto a **FORD**

HB211

Ø: 16.0mm

Cross Ref:

1704066 [FORD]

Suitable for:

TRANSIT 2.2MJT/TDCI - [2.2 -2.4 -3.2 CC]

Details:

Tenditore

Tenditore in metallo

Tensioner

Metal tensioner

Ø: 16.0mm



Adatto a **IVECO**

Suitable for **IVECO**

Ø: 70.0mm

H: 30.0mm



HB200

Cross Ref:

5801405072 [IVECO]

Suitable for:

CURSOR 9

BUS URBANWAY E6 - [8.7 CC]

Details:

Tendicinghia

Puleggia in metallo

Belt tensioner

Metal pulley

L: 30.0mm | H: 30.0mm | Ø: 70.0mm

Ø: 74.0mm

H: 34.0mm

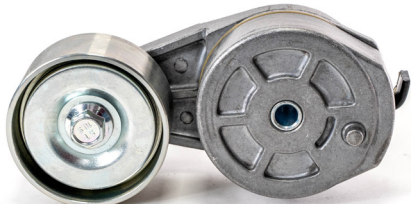

HB201

Cross Ref:

504315781 [IVECO]

Suitable for:

CURSOR 8

BUS / NEF - [3.9 - 7.8 CC]

Details:

Braccio tenditore

Puleggia in metallo

Tensioner lever

Metal pulley

L: 58.0mm | H: 34.0mm | Ø: 74.0mm

Ø: 70.0mm

H: 36.0mm



HB202

Cross Ref:

5801708165 [IVECO]

Suitable for:

CURSOR 9

BUS URBANWAY E6 - [8.7 CC]

Details:

Galoppino/Guidacinghia

Puleggia in metallo

Deflection/Guide pulley

Metal pulley

H: 36.0mm | Ø: 70.0mm

Suitable for **IVECO**

Adatto a **IVECO**

HB203

Ø: 74.0mm

H: 34.0mm

Cross Ref:

504315786 [IVECO]

Suitable for:

CURSOR 9
BUS URBANWAY EURO 6 - [8.7 CC]

Details:

Tendicinghia
Puleggia in metallo
Belt tensioner
Metal pulley
L: 175.0mm | H: 34.0mm | Ø: 74.0mm

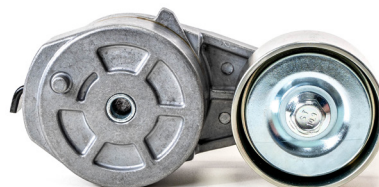

HB204

Ø: 74.0mm

H: 47.0mm

Cross Ref:

504356836 [IVECO]

Suitable for:

CURSOR 9
BUS URBANWAY EURO 6 - [8.7 CC]

Details:

Tendicinghia
Puleggia in metallo
Belt tensioner
Metal pulley
H: 47.0mm | Ø: 74.0mm



HB205

Ø: 70.0mm

H: 24.9mm

Cross Ref:

504106751 [IVECO]

Suitable for:

CURSOR 8
STRALIS/CITELIS - [2.8 - 7.8 CC]

Details:

Galoppino/guidacinghia
Puleggia in metallo
Deflection/Guide pulley
Metal pulley
L: 40.5mm | H: 24.9mm | Ø: 70.0mm



Adatto a **IVECO**

Suitable for **IVECO**

Ø: 74.0mm

H: 47.0mm



HB206

Cross Ref:

504356034 [IVECO]

Suitable for:

CURSOR 9

CITELIS - [8.7 CC]

Details:

Tendicinghia

Puleggia in metallo

Belt tensioner

Metal pulley

L: 67.0mm | H: 47.0mm | Ø: 74.0mm

Ø: 57.7mm

H: 46.3mm

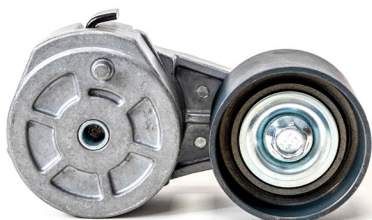

HB209

Cross Ref:

5801404997 [IVECO]

Suitable for:

CURSOR 9

BUS URBANWAY EURO 6 - [8.7 CC]

Details:

Tendicinghia

Puleggia in metallo

Belt tensioner

Metal pulley

L: 74.0mm | H: 46.3mm | Ø: 57.7mm

Ø: 85.2mm

H: 32.0mm



HB210

Cross Ref:

504315785 [IVECO]

Suitable for:

F4AFE612/F4AE368

EUROFIRE/EUROCARGO - [3.9 - 5.9 CC]

Details:

Tendicinghia

Puleggia in metallo

Belt tensioner

Metal pulley

L: 53.5mm | H: 32.0mm | Ø: 85.2mm

Suitable for **IVECO**

Adatto a **IVECO**

HB214

Ø: 65.0mm

H: 32.0mm

Cross Ref:

504065877 [IVECO]

Suitable for:

F4AE0482/3482/F4AE0682/3682
EUROCARGO - [3.9 - 5.9 CC]

Details:

Galoppino/guidacinghia
Puleggia in metallo
Deflection/Guide pulley
Metal pulley
H: 32.0mm | Ø: 65.0mm



HB218

Ø: 65.0mm

H: 32.0mm

Cross Ref:

504065878 [IVECO]

Suitable for:

F4AEE681G
TECTOR/EUROCARGO - [3.9 - 5.9 CC]

Details:

Galoppino/guidacinghia
Puleggia in metallo
Deflection/Guide pulley
Metal pulley
H: 32.0mm | Ø: 65.0mm



HB233

Ø: 21.0mm

L: 92.0mm

Cross Ref:

4279745 [IVECO]

Suitable for:

8140
DAILY I/II - [2.5 - 2.8 CC]

Details:

Rullo tenditore
Puleggia in metallo
Tensioner pulley
Metal pulley
L: 92.0mm | Ø: 21.0mm

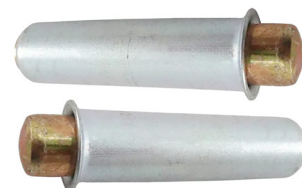

Adatto a **IVECO**

Suitable for **IVECO**

Ø: 74.0mm

H: 46.3mm

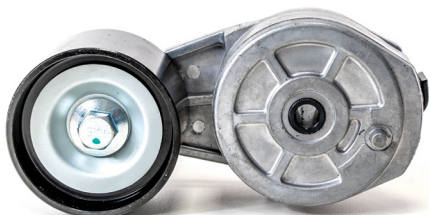

HB234

Cross Ref:

504046191 [IVECO]

Suitable for:

CURSOR 8/9/10/13

F2BE/F3AE/F3BE - [7.8 - 10.3 - 12.9 CC]

Details:

Tendicinghia

Puleggia in plastica

Belt tensioner

Plastic pulley

L: 62.7mm | H: 46.3mm | Ø: 74.0mm

Ø: 64.0mm

H: 37.0mm

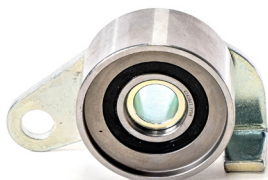

HB235

Cross Ref:

7301661 [IVECO]

Suitable for:

S8U

DAILY - [2.5 CC]

Details:

Tendicinghia

Puleggia in metallo

Belt tensioner

Metal pulley

H: 37.0mm | Ø: 64.0mm

Ø: 67.0mm

H: 34.0mm

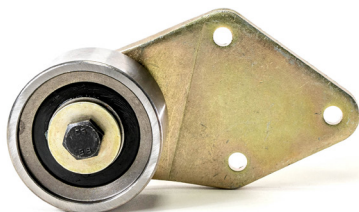

HB236

Cross Ref:

7301662 [IVECO]

Suitable for:

S8U

DAILY - [2.5 CC]

Details:

Tendicinghia

Puleggia in metallo

Belt tensioner

Metal pulley

H: 34.0mm | Ø: 67.0mm

Suitable for **IVECO**

Adatto a **IVECO**

HB237

Ø: 74.5mm

H: 85.0mm

Cross Ref:

4616156 [IVECO]

Suitable for:

8060

ZETA - [3.9 - 4.6 - 5.9 CC]

Details:

Tendicinghia

Puleggia in plastica

Belt tensioner

Plastic pulley

L: 120.0mm | H: 85.0mm | Ø: 74.5mm



HB238

Ø: 69.0mm

H: 34.0mm

Cross Ref:

5802473355 [IVECO]

Suitable for:

F1AE0481/3481

DAILY/DUCATO - [2.3 CC]

Details:

Rullo tenditore

Puleggia in plastica

Tensioner pulley

Plastic pulley

H: 34.0mm | Ø: 69.0mm



HB239

Ø: 60.0mm

H: 22.0mm

Cross Ref:

98429701 [IVECO]

Suitable for:

8140.43/8460.41

DAILY - [2.8 CC]

Details:

Galoppino/guidacinghia

Puleggia in metallo

Deflection/Guide pulley

Metal pulley

L: 22.0mm | H: 22.0mm | Ø: 60.0mm



Adatto a **IVECO**

Suitable for **IVECO**

Ø: 102.0mm

H: 182.0mm

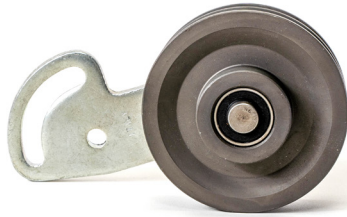

HB241

Cross Ref:

4803462 [IVECO]

Suitable for:

8040/8060 - GAMMA ZETA 65/79.12
[3.6 - 3.9 - 4.5 - 5.5 - 5.9 CC]

Details:

Tendicinghia
Puleggia in plastica
Belt tensioner
Plastic pulley
L: 67.0mm | H: 182.0mm | Ø: 102.0mm

Ø: 74.0mm

H: 47.0mm



HB242

Cross Ref:

504006261 [IVECO]

Suitable for:

CURSOR 8/10/13
STRALIS/EUROTRAKKER - [7.8 - 10.3 - 12.9 CC]

Details:

Galoppino/guidacinghia
Puleggia in metallo
Deflection/Guide pulley
Metal pulley
L: 75.0mm | H: 47.0mm | Ø: 74.0mm

Ø: 100.0mm

H: 171.0mm



HB243

Cross Ref:

98436012 [IVECO]

Suitable for:

8040/8060
EUROCARGO - [3.9 - 5.9 - 7.8 CC]

Details:

Tendicinghia
Puleggia in plastica
Belt tensioner
Plastic pulley
H: 171.0mm | Ø: 100.0mm

Suitable for **IVECO**

Adatto a **IVECO**

HB244

Ø: 166.0mm

Cross Ref:

500301088 [IVECO]

Suitable for:

8210.22V/42L/M/K
EUROSTAR/EUROTRAKKER - [7.8 - 12.9 CC]

Details:

Tendicinghia
Puleggia in metallo
Belt tensioner
Metal pulley
L: 239.0mm | Ø: 166.0mm



HB246

Ø: 67.0mm

H: 34.0mm

Cross Ref:

2997797 [IVECO]

Suitable for:

8140/G9U
DAILY - [2.5 - 2.8 CC]

Details:

Galoppino/Guidacinghia
Puleggia in metallo
Deflection/Guide pulley
Metal pulley
H: 34.0mm | Ø: 67.0mm



HB250

Ø: 70.0mm

H: 25.0mm

Cross Ref:

504086948 [IVECO]

Suitable for:

FICE
DAILY/DUCATO 3.0MJT/HDI - [3.0 CC]

Details:

Tendicinghia
Puleggia in plastica
Belt tensioner
Plastic pulley
L: 92.0mm | H: 25.0mm | Ø: 70.0mm

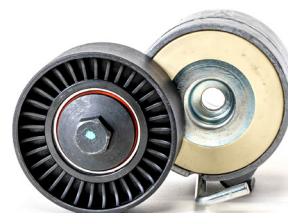

Adatto a **IVECO**

Suitable for **IVECO**

Ø: 73.0mm

H: 40.0mm

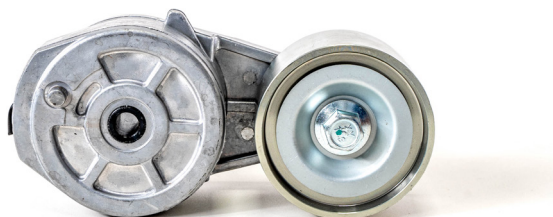

HB274

Cross Ref:

504072744 [IVECO]

Suitable for:

F2BE0681/260S31
STRALIS - [7.8 - 8.7 CC]

Details:

Tendicinghia
Puleggia in metallo
Belt tensioner
Metal pulley
L: 57.5mm | H: 40.0mm | Ø: 73.0mm

Ø: 70.3mm

H: 34.0mm



HB302

Cross Ref:

500388688 [IVECO]

Suitable for:

F1AE0481/3481
DAILY - [2.3 CC]

Details:

Galoppino/Guidacinghia
Puleggia in metallo
Deflection/Guide pulley
Metal pulley
H: 34.0mm | Ø: 70.3mm

Ø: 65.0mm

H: 23.0mm



HB306

Cross Ref:

500042993 [IVECO]

Suitable for:

8140.43 S
DAILY I/III - [2.8 CC]

Details:

Tendicinghia
Puleggia in plastica
Belt tensioner
Plastic pulley
L: 83.7mm | H: 23.0mm | Ø: 65.0mm

Suitable for **IVECO**

Adatto a **IVECO**

HB310

Cross Ref:

500042740 [IVECO]

Suitable for:

8140/G9U
DAILY - [2.5 - 2.8 CC]

Details:

Galoppino/Guidacinghia
Puleggia in metallo
Deflection/Guide pulley
Metal pulley
H: 34.0mm | Ø: 63.5mm

Ø: 63.5mm

H: 34.0mm



HB314

Cross Ref:

504086751 [IVECO]

Suitable for:

F1AE0481
DAILY 35C10/S10 - [2.3 CC]

Details:

Tendicinghia
Puleggia in plastica
Belt tensioner
Plastic pulley
L: 92.5mm | H: 28.5mm | Ø: 70.0mm

Ø: 70.0mm

H: 28.5mm



HB326

Cross Ref:

504153873 [IVECO]

Suitable for:

F2BE0681/CURSOR 8
STRALIS - [7.8 - 10.3 CC]

Details:

Tendicinghia
Puleggia in metallo
Belt tensioner
Metal pulley
L: 43.7mm | H: 18.5mm | Ø: 65.0mm

Ø: 65.0mm

H: 18.5mm



Adatto a **IVECO**

Suitable for **IVECO**

Ø: 74.0mm

H: 47.0mm



HB338

Cross Ref:

5801674387 [IVECO]

Suitable for:

F3HFE611/F3GFE611
STRALIS - [11.2 - 12.9 CC]

Details:

Galoppino/guidacinghia
Puleggia in metallo
Deflection/Guide pulley
Metal pulley
H: 47.0mm | Ø: 74.0mm

Ø: 70.0mm

H: 25.0mm



HB354

Cross Ref:

504106749 [IVECO]

Suitable for:

F2BE0681/682
STRALIS - [7.8 CC]

Details:

Tendicinghia
Puleggia in metallo
Belt tensioner
Metal pulley
L: 75.5mm | H: 25.0mm | Ø: 70.0mm

Suitable for **MAN**

Adatto a **MAN**

HB212

Ø: 74.0mm

H: 34.0mm

Cross Ref:

51.95800-7428 [MAN]

Suitable for:

D 2066 LF01
ECT/TGA/TGS - [10.5 - 12.0 - 12.8 CC]

Details:

Tendicinghia
Puleggia in metallo
Belt tensioner
Metal pulley
L: 84.0mm | H: 34.0mm | Ø: 74.0mm

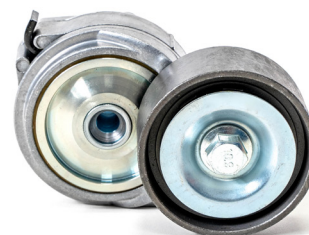

HB220

Ø: 74.0mm

H: 34.0mm

Cross Ref:

51.95800-7385 [MAN]

Suitable for:

D 2866 LF20>27
TGA/E/F 2000 - [12.0 - 12.8 CC]

Details:

Tendicinghia
Puleggia in metallo
Belt tensioner
Metal pulley
L: 58.0mm | H: 34.0mm | Ø: 74.0mm



HB221

Ø: 42.2mm

H: 33.9mm

Cross Ref:

51.95800-6099 [MAN]

Suitable for:

D0834/836/2676
TGI/TGM/TGX SERIES - [10.5 - 12.4 CC]

Details:

Tendicinghia
Puleggia in metallo
Belt tensioner
Metal pulley
H: 33.9mm | Ø: 42.2mm



Adatto a **MERCEDES**

Suitable for **MERCEDES**

Ø: 74.0mm

Suitable for **MERCEDES**

H: 35.5mm

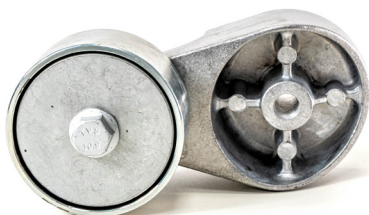

HB207

Cross Ref:

A9062004670 [MERCEDES]

Suitable for:

OM904/906/926

AXOR/ATEGO/ECONIC - [4.3 - 6.4 - 7.2 CC]

Details:

Tendicinghia

Puleggia in metallo

Belt tensioner

Metal pulley

L: 99.5mm | H: 35.5mm | Ø: 74.0mm

Ø: 75.0mm

H: 32.7mm



HB208

Cross Ref:

A9062004570 [MERCEDES]

Suitable for:

OM904/906/926

AXOR/ATEGO/ECONIC - [4.3 - 6.4 CC]

Details:

Tendicinghia

Puleggia in metallo

Belt tensioner

Metal pulley

L: 91.3mm | H: 32.7mm | Ø: 75.0mm

Ø: 80.0mm

H: 34.0mm



HB213

Cross Ref:

A4572001970 [MERCEDES]

Suitable for:

OM457

AXOR SERIES - [12.0 CC]

Details:

Tendicinghia

Puleggia in metallo

Belt tensioner

Metal pulley

L: 102.5mm | H: 34.0mm | Ø: 80.0mm

Suitable for **MERCEDES**

Adatto a **MERCEDES**

HB215

Cross Ref:

A5412000870 [MERCEDES]

Suitable for:

OM541

ACTROS SERIES - [12.0 - 16.0 CC]

Details:

Tendicinghia

Puleggia in plastica

Belt tensioner

Plastic pulley

L: 61.0mm | H: 34.0mm | Ø: 74.0mm

Ø: 74.0mm

H: 34.0mm

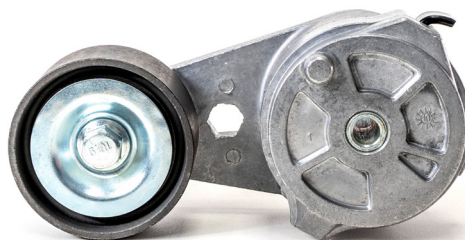

HB216

Cross Ref:

A9062000470 [MERCEDES]

Suitable for:

OM904

VARIO SERIES - [4.2 - 6.4 CC]

Details:

Galoppino/guidacinghia

Puleggia in metallo

Deflection/Guide pulley

Metal pulley

L: 25.2mm | H: 34.0mm | Ø: 106.6mm

Ø: 106.6mm

H: 34.0mm



HB224

Cross Ref:

A0005500833 [MERCEDES]

Suitable for:

OM457

AXOR SERIES - [12.0 CC]

Details:

Galoppino/guidacinghia

Puleggia in metallo

Deflection/Guide pulley

Metal pulley

H: 80.0mm | Ø: 48.0mm

Ø: 48.0mm

H: 80.0mm



Adatto a **MERCEDES**

Suitable for **MERCEDES**

Ø: 70.2mm

Suitable for **MERCEDES**

H: 34.6mm



HB225

Cross Ref:

A0002001070 [MERCEDES]

Suitable for:

OM457/OM926

AXOR/CITARO - [7.2 - 12.0 CC]

Details:

Tendicinghia

Puleggia in metallo

Belt tensioner

Metal pulley

L: 68.6mm | H: 34.6mm | Ø: 70.2mm

Ø: 74.0mm

H: 46.3mm



HB231

Cross Ref:

4572001470 [MERCEDES]

Suitable for:

OM457/OM906

AXOR/CITARO/ECONIC - [6.4 - 12.0 CC]

Details:

Tendicinghia

Puleggia in metallo

Belt tensioner

Metal pulley

L: 106.4mm | H: 46.3mm | Ø: 74.0mm

Ø: 80.0mm

H: 45.0mm

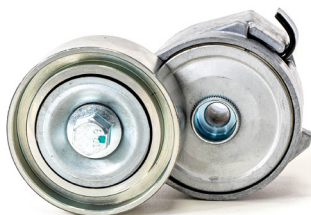

HB254

Cross Ref:

A5412001070 [MERCEDES]

Suitable for:

ATROS MP2/3/4/5 - [12.0 - 16.0 CC]

Details:

Tendicinghia

Puleggia in metallo

Belt tensioner

Metal pulley

L: 68.0mm | H: 45.0mm | Ø: 80.0mm

Suitable for **OPEL**

Adatto a **OPEL**

HB233

Ø: 21.0mm

L: 92.0mm

Cross Ref:

9108200 [OPEL]

Suitable for:

S9W 700

MOVANO - [2.5 - 2.8 CC]

Details:

Rullo tenditore

Puleggia in metallo

Tensioner pulley

Metal pulley

L: 92.0mm | Ø: 21.0mm

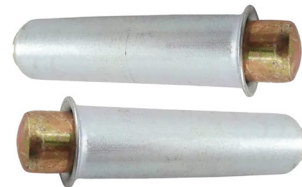

Adatto a **PEUGEOT**

Suitable for **PEUGEOT**

Ø: 21.0mm

L: 92.0mm

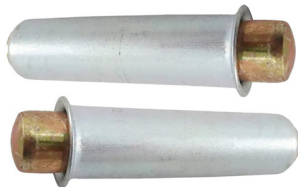

HB233

Cross Ref:

82965 [PEUGEOT]

Suitable for:

8140

BOXER - [2.5 - 2.8 CC]

Details:

Rullo tenditore

Puleggia in metallo

Tensioner pulley

Metal pulley

L: 92.0mm | Ø: 21.0mm

Ø: 64.0mm

H: 37.0mm

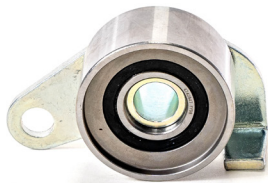

HB235

Cross Ref:

81832 [PEUGEOT]

Suitable for:

BOXER - [2.5 CC]

Details:

Tendicinghia

Puleggia in metallo

Belt tensioner

Metal pulley

H: 37.0mm | Ø: 64.0mm

Ø: 67.0mm

H: 34.0mm

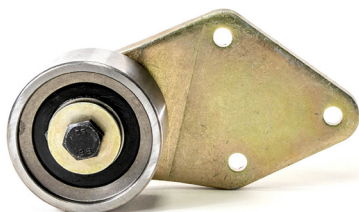

HB236

Cross Ref:

00818.32 [PEUGEOT]

Suitable for:

8140.43S

BOXER - [2.5 CC]

Details:

Tendicinghia

Puleggia in metallo

Belt tensioner

Metal pulley

H: 34.0mm | Ø: 67.0mm

Suitable for **RENAULT**

Adatto a **RENAULT**

HB222

Ø: 74.0mm

H: 38.3mm

Cross Ref:

7420935521 [RENAULT]

Suitable for:

DXI11

KERAX/PREMIUM 2 - [12.8 CC]

Details:

Tendicinghia

Puleggia in metallo

Belt tensioner

Metal pulley

L: 59.3mm | H: 38.3mm | Ø: 74.0mm



HB226

Ø: 74.0mm

H: 38.4mm

Cross Ref:

7420521447 [RENAULT]

Suitable for:

DXI13

MAGNUM/KERAX - [12.8 CC]

Details:

Galoppino/guidacinghia

Puleggia in metallo

Deflection/Guide pulley

Metal pulley

L: 94.5mm | H: 38.4mm | Ø: 74.0mm



HB227

Ø: 78.6mm

H: 37.5mm

Cross Ref:

7420759364 [RENAULT]

Suitable for:

DXI 5/7

MIDLUM/PREMIUM - [4.8 - 7.2 CC]

Details:

Galoppino/guidacinghia

Puleggia in metallo

Deflection/Guide pulley

Metal pulley

H: 37.5mm | Ø: 78.6mm



Adatto a **RENAULT**

Suitable for **RENAULT**

Ø: 21.0mm

L: 92.0mm

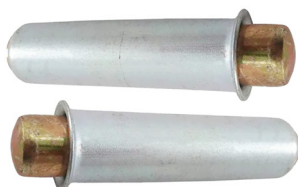

HB233

Cross Ref:

5001001263 [RENAULT]

Suitable for:

G9U/S8U

MASTER/TRAFIC - [2.5 - 2.8 CC]

Details:

Rullo tenditore

Puleggia in metallo

Tensioner pulley

Metal pulley

L: 92.0mm | Ø: 21.0mm

Ø: 64.0mm

H: 37.0mm

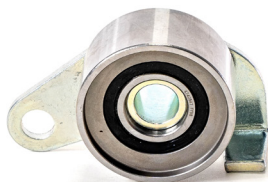

HB235

Cross Ref:

7701040204 [RENAULT]

Suitable for:

S8U

MASTER I 2.5 D - [2.5 CC]

Details:

Tendicinghia

Puleggia in metallo

Belt tensioner

Metal pulley

H: 37.0mm | Ø: 64.0mm

Ø: 67.0mm

H: 34.0mm

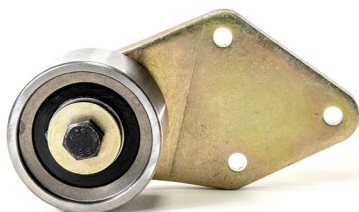

HB236

Cross Ref:

5001001259 [RENAULT]

Suitable for:

S8U

MASTER I 2.5 D - [2.5 CC]

Details:

Tendicinghia

Puleggia in metallo

Belt tensioner

Metal pulley

H: 34.0mm | Ø: 67.0mm

Suitable for **RENAULT**

Adatto a **RENAULT**

HB266

Cross Ref:

7421257889 [RENAULT]

Suitable for:

DCI 11C/DXI12
REMIUM/KERAX/MAGNUM - [7.2 - 9.4 - 10.8 - 12.1 CC]

Details:

Tendicinghia
Puleggia in metallo
Belt tensioner
Metal pulley
L: 70.5mm | H: 38.3mm | Ø: 74.0mm

Ø: 74.0mm

H: 38.3mm



HB270

Cross Ref:

8149855 [RENAULT]

Suitable for:

D11A/B/C/K/D12A/C/D/D16C/E/G
MAGNUM - [12.1 CC]

Details:

Tendicinghia
Puleggia in plastica
Belt tensioner
Plastic pulley
L: 78.3mm | H: 38.3mm | Ø: 74.0mm

Ø: 74.0mm

H: 38.3mm



HB278

Cross Ref:

7420487079 [RENAULT]

Suitable for:

DXI13
KERAX/MAGNUM - [12.8 CC]

Details:

Tendicinghia
Puleggia in metallo
Belt tensioner
Metal pulley
L: 77.1mm | H: 38.3mm | Ø: 74.0mm

Ø: 74.0mm

H: 38.3mm



Adatto a **RENAULT**

Suitable for **RENAULT**

Ø: 76.2mm

H: 24.0mm

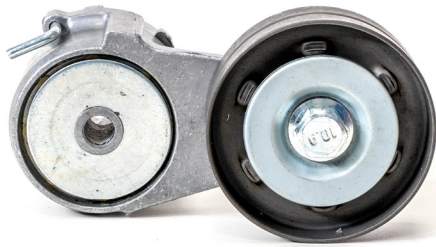

HB286

Cross Ref:

5010412957 [RENAULT]

Suitable for:

DCI 11

KERAX - [11.0 CC]

Details:

Tendicinghia

Puleggia in metallo

Belt tensioner

Metal pulley

L: 97.0mm | H: 24.0mm | Ø: 76.2mm

Ø: 74.8mm

H: 39.4mm



HB290

Cross Ref:

7408086970 [RENAULT]

Suitable for:

DXI 11

KERAX/PREMIUM 2 - [10.8 CC]

Details:

Galoppino/guidacinghia

Puleggia in plastica

Deflection/Guide pulley

Plastic pulley

H: 39.4mm | Ø: 74.8mm

Ø: 63.5mm

H: 34.0mm



HB310

Cross Ref:

5001001272 [RENAULT]

Suitable for:

G9U

MASTER - [2.5 - 2.8 CC]

Details:

Galoppino/Guidacinghia

Puleggia in metallo

Deflection/Guide pulley

Metal pulley

H: 34.0mm | Ø: 63.5mm

Suitable for **SCANIA**

Adatto a **SCANIA**

HB217

Cross Ref:

2197005 [SCANIA]

Suitable for:

DC 09.108-113

P/G/R/T SERIES - [8.9 - 9.3 - 10.6 - 11.7 CC]

Details:

Tendicinghia

Puleggia in plastica

Belt tensioner

Plastic pulley

L: 67.5mm | H: 32.0mm | Ø: 74.0mm

Ø: 74.0mm

H: 32.0mm



HB219

Cross Ref:

1510697 [SCANIA]

Suitable for:

DC 09/11/12

P/G/R/T 4-SERIES - [8.9 - 9.3 CC]

Details:

Galoppino/guidacinghia

Puleggia in plastica

Deflection/Guide pulley

Plastic pulley

L: 37.1mm | H: 32.0mm | Ø: 74.0mm

Ø: 74.0mm

H: 32.0mm



HB330

Cross Ref:

1774652 [SCANIA]

Suitable for:

DC16

P/G/R/T 4-SERIES 2000-> - [15.6 CC]

Details:

Tendicinghia

Puleggia in plastica

Belt tensioner

Plastic pulley

L: 67.5mm | H: 32.0mm | Ø: 74.0mm

Ø: 74.0mm

H: 32.0mm



Adatto a **SCANIA**

Suitable for **SCANIA**

Ø: 74.0mm

H: 31.0mm



HB346

Cross Ref:

1774653 [SCANIA]

Suitable for:

DC16

P/G/R/T SERIES 2000-> - [15.6 CC]

Details:

Tendicinghia

Puleggia in plastica

Belt tensioner

Plastic pulley

L: 67.5mm | H: 31.0mm | Ø: 74.0mm

Suitable for **VOLVO**

Adatto a **VOLVO**

HB222

Cross Ref:

21422765 [VOLVO]

Suitable for:

DH12E340/380/420/460
[12.8 CC]

Details:

Tendicinghia
Puleggia in metallo
Belt tensioner
Metal pulley
L: 59.3mm | H: 38.3mm | Ø: 74.0mm

Ø: 74.0mm

H: 38.3mm

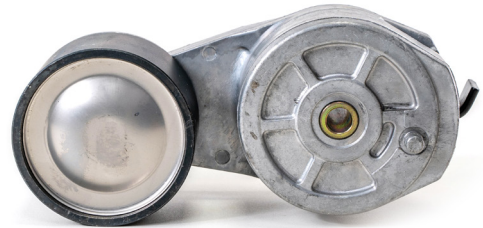

HB226

Cross Ref:

21766717 [VOLVO]

Suitable for:

D13A400/440
FH/FM/FMX - [12.8 CC]

Details:

Galoppino/guidacinghia
Puleggia in metallo
Deflection/Guide pulley
Metal pulley
L: 94.5mm | H: 38.4mm | Ø: 74.0mm

Ø: 74.0mm

H: 38.4mm



HB227

Cross Ref:

21390528 [VOLVO]

Suitable for:

D7E280
FL SERIES - [4.8 - 7.2 CC]

Details:

Galoppino/guidacinghia
Puleggia in metallo
Deflection/Guide pulley
Metal pulley
H: 37.5mm | Ø: 78.6mm

Ø: 78.6mm

H: 37.5mm



Adatto a **VOLVO**

Suitable for **VOLVO**

Ø: 78.5mm

H: 38.4mm



HB228

Cross Ref:

21631484 [VOLVO]

Suitable for:

FH16B

FH SERIES - [16.1 CC]

Details:

Tendicinghia

Puleggia in metallo

Belt tensioner

Metal pulley

L: 69.2mm | H: 38.4mm | Ø: 78.5mm

Ø: 74.0mm

H: 38.3mm



HB266

Cross Ref:

21257889 [VOLVO]

Suitable for:

D10/D11/D12/D13-B

FH/FM/NH SERIES - [7.2 - 9.4 - 10.8 - 12.1 CC]

Details:

Tendicinghia

Puleggia in metallo

Belt tensioner

Metal pulley

L: 70.5mm | H: 38.3mm | Ø: 74.0mm

Ø: 74.0mm

Suitable for **VOLVO**

H: 38.3mm



HB278

Cross Ref:

20487079 [VOLVO]

Suitable for:

D13A/B/C/K

FH/FM/FMX - [12.8 CC]

Details:

Tendicinghia

Puleggia in metallo

Belt tensioner

Metal pulley

L: 77.1mm | H: 38.3mm | Ø: 74.0mm

Suitable for **VOLVO**

Adatto a **VOLVO**

Ø: 74.8mm

Suitable for **VOLVO**

H: 39.4mm



HB290

Cross Ref:

8086970 [VOLVO]

Suitable for:

D11K330/D9B380

FM - [10.8 CC]

Details:

Galoppino/guidacinghia

Puleggia in plastica

Deflection/Guide pulley

Plastic pulley

H: 39.4mm | Ø: 74.8mm



Cinghie trasmissione Transmission belts.

*Per applicazione bus, veicoli commerciali leggeri e pesanti
Suitable for bus, LCV and HDV applications.*

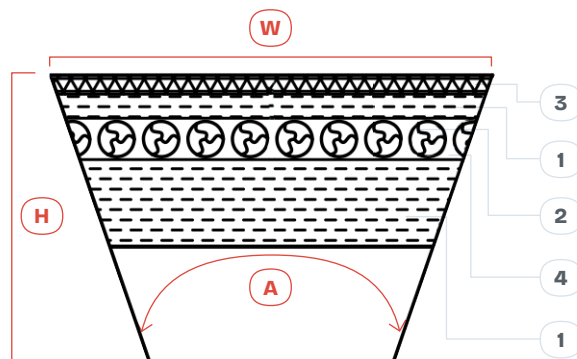

	Thickness [H]	Width [W]	Angle [A]	Angle symmetry [A/2]
AVX10	8.0±0.8mm	10.0±0.5mm	36°±2.0	a ₁ : 18°±1.5 a ₂ : 18°±1.5
AVX13	8.0±0.8mm	13.0±0.5mm	36°±2.0	a ₁ : 18°±1.5 a ₂ : 18°±1.5

CINGHIE TRAPEZOIDALI DENTELLATE

È la cinghia storica per eccellenza. Nonostante sia una cinghia con un numero minore di applicazioni rispetto al passato, la cinghia AVX HEAVYBELT rimane sempre un prodotto altamente tecnologico costruito seguendo gli standard qualitativi più alti. Il risultato è un prodotto che non ha nulla da invidiare al ricambio OE, sia come costruzione che come durata nel tempo.

Le cinghie AVX HEAVYBELT sono disponibili con larghezza da 10 mm e da 13 mm.

V-BELTS RAW EDGE. MOULDED COGGED

AVX is the main historical belt. Despite its lower number of applications compared to the past, the AVX HEAVYBELT belt is a high technological product, manufactured following the highest standards of quality.

The result is a long-lasting product, whose construction can be totally compared to the OEM product.

AVX HEAVYBELT belts are available in 10 mm and 13 mm width.

1. BODY COMPOUND EPDM RUBBER WITH POLYESTER FIBERS
2. POLYESTER CORD 1100/2x3 FOK/EPDM (AVX10)
POLYESTER CORD 1100/3x3 FOK/EPDM (AVX13)
3. ONE EPDM RUBBERIZED NYLON 2x2 TOP FABRIC LAYER
4. ADHESION EPDM RUBBER COMPOUND

BELT MARKING EXAMPLE

BRAND	CODE	MATERIAL	PRODUCTION
HEAVYBELT	AVX13X1310	>EPDM<	S42 002 N01
HEAVYBELT	AVX13X1310	>EPDM<	S42 003 N01

PK

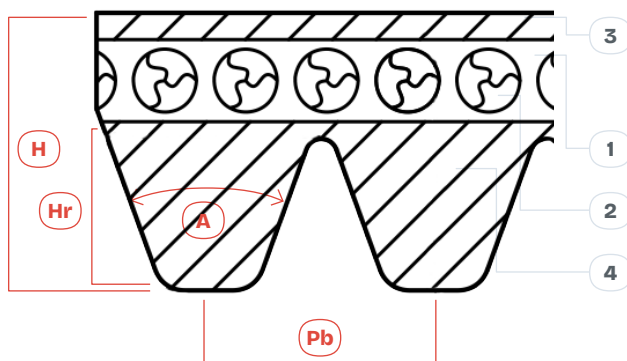

	Thickness [H]	Angle [A]	Pitch [Pb]	Rib height [Hr]
PK	4.2±0.3mm	40°±2.0	3.56±0.05mm	2.0±0.3mm

CINGHIE MULTI-GOLA

Le cinghie POLI-V HEAVYBELT sono tutte costruite in EPDM per ottenere un prodotto flessibile e resistente alle alte temperature (-40 °C/+120 °C), nel rispetto degli standard qualitativi di precisione dei profili che di lunghezza.

Il risultato è una cinghia dalle elevate prestazioni, lunga durata e alta resistenza, quanto richiesto da un ricambio per il settore TRUCK e BUS.

All'interno della gamma HEAVYBELT POLI-V sono presenti anche tipologie di cinghie elastiche (EPK), qualora fosse richiesto il montaggio senza tenditore.

RIBBED BELTS

POLI-V HEAVYBELT belts are manufactured in EPDM, a temperature resistant rubber (-40 °C/+120 °C), which guarantees the best flexibility, in full compliance with the highest quality standards for both profiles precision and length control.

The result is a high performing, long-lasting and resistant belt, the best solution for our trucks and buses spare parts sector.

Inside the HEAVYBELT POLI-V assortment are also available ELASTIC BELT (EPK), to supply the request of an assembly without tension.

1. ADHESION EPDM RUBBER COMPOUND
2. POLYESTER CORD
3. COVER RUBBER (EPDM)
4. BOTTOM RUBBER (EPDM)

BELT MARKING EXAMPLE



BRAND	CODE	MATERIAL	PRODUCTION
HEAVYBELT	4PK1026	>EPDM<	S29 002 N01
HEAVYBELT	4PK1026	>EPDM<	S29 003 N01

XPB

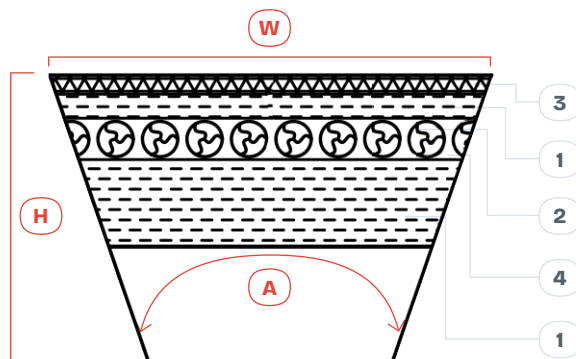

	Thickness [H]	Width [W]	Angle [A]	Angle simmetry [A/2]
XPB	13.0±0.8mm	16.3±0.5mm	40°±2.0	a ₁ : 20°±1.5 a ₂ : 20°±1.5

CINGHIE TRAPEZOIDALI DENTellate

Cinghie altamente performanti studiate espressamente per gli impianti di condizionamento dei principali bus.

Le cinghie XPB HEAVYBELT sono state progettate e costruite per resistere alle alte temperature e all'uso critico in applicazioni su autobus.

Sono disponibili nella versione singola e nella versione multigola.

V-BELTS RAW EDGE. MOULDED COGGED

High-performing belts expressly manufactured for the airconditioning of the most important buses.

XPB HEAVYBELT belts are specifically manufactured to resist to high temperatures and for bus applications.

These belts are available in single or Poly-V version.

1. BODY COMPOUND EPDM RUBBER WITH POLYESTER FIBERS
2. POLYESTER CORD 1100/4x3 FOK/EPDM
3. ONE EPDM RUBBERIZED NYLON 2x2 TOP FABRIC LAYER
4. ADHESION EPDM RUBBER COMPOUND

BELT MARKING EXAMPLE

HEAVYBELT	XPB1700	>EPDM<	S42 001 N01
HEAVYBELT	XPB1700	>EPDM<	S42 002 N01
HEAVYBELT	XPB1700	>EPDM<	S42 003 N01

BRAND	CODE	MATERIAL	PRODUCTION
-------	------	----------	------------

References	Car maker	Type	Dimensions
LEMAVX101000L 4803951	IVECO BUS A135.14	DENT A	W: 10mm L: 1000mm
LEMAVX101000L 4803951	IVECO 65/79.12 TURBOZETA-79/95/109.14 TURBOZETA-115/135.14-115/135/145/175.17	DENT A	W: 10mm L: 1000mm
LEMAVX101000L 0059975192	MERCEDES OM355/5	DENT A	W: 10mm L: 1000mm
LEMAVX101000L 6580731211	MAN A135.14	DENT -	W: 10mm L: 1000mm
LEMAVX101000L 5000297765	RENAULT TP3-SG2-SG3-SG4	DENT A	W: 10mm L: 1000mm
LEMAVX101025L 48142754818162	IVECO BUS A70.14 ZETA-A90.14 ZETA-A135.14-A135.17 3480.18.29-TURBOCITY 480/580/680	DENT A	W: 10mm L: 1025mm
LEMAVX101025L 4814275	IVECO 65.12TURBOZETA-115.14-115.17-135.17-79.14 ZETA-109.14-330.30	DENT A	W: 10mm L: 1025mm
LEMAVX101050L 0067664	DAF DHS 825 - F2500	DENT -	W: 10mm L: 1050mm
LEMAVX101050L 2991720	IVECO 160NC-643N-683N-684N-684T-684NP-684TP-690N3/N4-693N/N1	DENT A	W: 10mm L: 1050mm
LEMAVX101050L 2991720	IVECO BUS 331	DENT A	W: 10mm L: 1050mm
LEMAVX101050L 966693	VOLVO F84-F85-F86-F87-F6-N86 BUS B54-B6F	DENT A	W: 10mm L: 1050mm
LEMAVX101060L 98410144	IVECO 190.30TURBOTECH-190.30N/NT-330.30N/NW-330.36H	DENT A	W: 10mm L: 1060mm
LEMAVX101060L 966381	VOLVO N10-N12	DENT A	W: 10mm L: 1060mm
LEMAVX101075L 4654911	IVECO DAILY-190/330.30H/HT/HW	DENT A	W: 10mm L: 1075mm
LEMAVX101075L 6580731242	MAN DAILY-190/330.30H/HT/HW	DENT -	W: 10mm L: 1075mm
LEMAVX101100L 4799496	IVECO BUS 314-315.13-316.13	DENT P - V	W: 10mm L: 1100mm
LEMAVX101100L 4799496	IVECO 40/40/35/50/55-50/55/60.8-95/109.14 3°S-110NC-115/135.14 1°S	DENT P - V	W: 10mm L: 1100mm

DENT: Dentata - Cogged | **DENT-2:** Dentata accoppiata - Cogged 2 ribs | **DENT-3:** Dentata tripla - Cogged 3 ribs | **MULT:** Multipla - Kraftbands
LISCIA: Non dentata - Not cogged | **A:** Alternatore - Alternator | **C:** Condizionatore - Air conditioner | **CPR:** Compressore - Compressor | **D:** Distribu-
 zione - Timing system | **P:** Pompa acqua - Water pump | **V:** Ventilatore - Fan | **PS:** Idroguida - Power steering | **HP:** Pompa idraulica - Hydraulic pump

References	Car maker	Type	Dimensions
LEMAVX101100L 6580731252	MAN 314-315.13-316.13	DENT -	W: 10mm L: 1100mm
LEMAVX101100L 968936	VOLVO F4-N7	DENT A	W: 10mm L: 1100mm
LEMAVX101125L 4688853	IVECO 65/75/90PC-100/110NC (?1979)-110.14-115/135.17 1°S645/650/662N3	DENT P - V	W: 10mm L: 1125mm
LEMAVX101125L 966845 976485	VOLVO F86-FB86-N86-NB86 FL6-F7-FL7-FL10N10-NL10-N12-NL12-BUS B58-B10M	DENT A - P - V	W: 10mm L: 1125mm
LEMAVX101125L 5001821492	RENAULT GR/TR350-GRH/TRH350-R360 (4X2-6X4)-R370/390/420 M140/160/200/230-C230/280/300/340TI-PS150/160	DENT A - P	W: 10mm L: 1125mm
LEMAVX101140L 4809679	IVECO 79/80/90/100.13-79.14 3°S-80/90NC-OMN100-100EC50/65.9 ZETA-60.11 TURBOZETA-645/650/662N1/N2	DENT P - V	W: 10mm L: 1140mm
LEMAVX101150L 4706573 98473706	IVECO BUS 370.26 (1°T)	DENT A	W: 10mm L: 1150mm
LEMAVX101150L 4706573 98473706	IVECO 110.16 ANW-120.13 AN/ANW-120.16 ANW-130.13 A/AH/AN-130.16 A/AH/AT	DENT A	W: 10mm L: 1150mm
LEMAVX101150L 966696 976486	VOLVO F7 USA-FS7BUS B10B-B10M-B10R	DENT A	W: 10mm L: 1150mm
LEMAVX101175L 6580731282	MAN BUS LION'S COACH - NG/NÜ/SÜ/ÜL	DENT A	W: 10mm L: 1175mm
LEMAVX101175L 11920D8800	NISSAN ATLEON TK165/210 (MOT. B660TI / 2000-2006) ATLEON ECO-T MTR (1996-2000)	DENT PS	W: 10mm L: 1175mm
LEMAVX101175L 5001865906	RENAULT MIDLINER (NO U.K.)	DENT A	W: 10mm L: 1175mm
LEMAVX101175L 966383 976489	VOLVO F88-FB88-G88-F89-FB89-F10-F12-F16-FL6-FL7 BUS B6-B7R CON INTERCOOLER / WITH INTERCOOLER	DENT A	W: 10mm L: 1175mm
LEMAVX101200L 5000816444	RENAULT JN55/60/65/75/85-S130/150TI (VF6JN)	DENT A	W: 10mm L: 1200mm
LEMAVX101200L 976490	VOLVO FL6-F7-FL10-NL12 BUS B58BR-B10B SENZA INTERCOOLER / WITHOUT INTERCOOLER	DENT A	W: 10mm L: 1200mm

DENT: Dentata - Cogged | **DENT-2:** Dentata accoppiata - Cogged 2 ribs | **DENT-3:** Dentata tripla - Cogged 3 ribs | **MULT:** Multipla - Kraftbands
LISCIA: Non dentata - Not cogged | **A:** Alternatore - Alternator | **C:** Condizionatore - Air conditioner | **CPR:** Compressore - Compressor | **D:** Distribu-
zione - Timing system | **P:** Pompa acqua - Water pump | **V:** Ventilatore - Fan | **PS:** Idroguida - Power steering | **HP:** Pompa idraulica - Hydraulic pump

References	Car maker	Type	Dimensions
LEMAVX101225L 5000297763	RENAULT G170-S170-S150TI (VF6JN)-S150TI/170 (VF6JP)	DENT A - P	W: 10mm L: 1225mm
LEMAVX101250L 2991718 4727249	IVECO BUS 314-370.25 (1°T)-370.35 (1°T)-AP160	DENT A	W: 10mm L: 1250mm
LEMAVX101250L 1251720	DAF F95	DENT -	W: 10mm L: 1250mm
LEMAVX101250L 6580731312	MAN 314-370.25 (1°T)-370.35 (1°T)-AP160	DENT -	W: 10mm L: 1250mm
LEMAVX101250L 5000691377	RENAULT MIDLINER-PREMIUM PR-MIDLUM-S130/180TI-S110	DENT A	W: 10mm L: 1250mm
LEMAVX101250L 966385 976115	VOLVO F12BUS B58-B10M SENZA INTERCOOLER / WITHOUT INTERCOOLER	DENT A	W: 10mm L: 1250mm
LEMAVX101264L 5010553925	RENAULT PREMIUM-PREMIUM DCI-MIDLUM-MIDLUM DCI	DENT A - P	W: 10mm L: 1264mm
LEMAVX101275L 0067665	DAF 85 FAD/FTT/95 FAD/FTT	DENT -	W: 10mm L: 1275mm
LEMAVX101275L 6580731322	MAN D 0826 - G 90	DENT -	W: 10mm L: 1275mm
LEMAVX101275L 5010258298	RENAULT S135-M210/P	DENT -	W: 10mm L: 1275mm
LEMAVX101275L 947932 - 958366	VOLVO 740/940/960	DENT A	W: 10mm L: 1275mm
LEMAVX101300L 98473884	IVECO BUS A70.14 ZETA-A90.14 ZETA	DENT C - P - V	W: 10mm L: 1300mm
LEMAVX101300L 98473884	IVECO 50/55F9-50/55/60/70/75/79.10-115.17-150.14/17-159.1765/79.12 TURBOZETA-79/95/109.14 ZETA-115/135.14115/135/145/175.17	DENT C - P - V	W: 10mm L: 1300mm
LEMAVX101300L 5000816447 5000686853	RENAULT GB/TB190/231-GR191/231-GLC/GLR190/230 PS150/160-MACK CS/MS200/250/300	DENT A - P	W: 10mm L: 1300mm
LEMAVX101325L 98473883	IVECO BUS 370S35	DENT A	W: 10mm L: 1325mm
LEMAVX101325L 947635	VOLVO BUS B59-B10R	DENT A	W: 10mm L: 1325mm

DENT: Dentata - Cogged | **DENT-2:** Dentata accoppiata - Cogged 2 ribs | **DENT-3:** Dentata tripla - Cogged 3 ribs | **MULT:** Multipla - Kraftbands
LISCIA: Non dentata - Not cogged | **A:** Alternatore - Alternator | **C:** Condizionatore - Air conditioner | **CPR:** Compressore - Compressor | **D:** Distribu-
 zione - Timing system | **P:** Pompa acqua - Water pump | **V:** Ventilatore - Fan | **PS:** Idroguida - Power steering | **HP:** Pompa idraulica - Hydraulic pump

References	Car maker	Type	Dimensions
LEMAVX101350L 5000297575	RENAULT GB/GR/TB191/231-GLC/GLR190/230-G210/230/270	DENT A	W: 10mm L: 1350mm
LEMAVX101350L 976494	VOLVO BUS B59-B10B-C10M-B12	DENT A	W: 10mm L: 1350mm
LEMAVX101375L 2234343 4766300	IVECO BUS 409-418AC-418AL-420A (1°T)315.17 TURBO	DENT A - C - P	W: 10mm L: 1375mm
LEMAVX101375L 2234343 4766300	IVECO 120.13 AN-120.13 ANW-130.13 A-130.13 AH	DENT V	W: 10mm L: 1375mm
LEMAVX101375L 6580731362	MAN 409-418AC-418AL-420A (1°T)315.17 TURBO	DENT -	W: 10mm L: 1375mm
LEMAVX101400L 2235177 4863028	IVECO BUS 370.26 (2°T)	DENT P	W: 10mm L: 1400mm
LEMAVX101400L 2235177 4863028	IVECO 110.16 ANW-120.16 ANW-130.16 A/AH/AT-150.16 AN/ANW	DENT V	W: 10mm L: 1400mm
LEMAVX101400L 977387	VOLVO BUS B9M-B10M (2X55A)	DENT A	W: 10mm L: 1400mm
LEMAVX101425L 4749775	IVECO BUS 370.25 (2°T)-370.35 (2°T)-370S35	DENT P	W: 10mm L: 1425mm
LEMAVX101425L 6580731381	MAN D0224MF-D0226MF/MK/MKF 12.136-14.136	DENT A	W: 10mm L: 1425mm
LEMAVX101425L 976496	VOLVO BUS B10M	DENT A	W: 10mm L: 1425mm
LEMAVX101450L	UNIVERSAL APPLICAZIONI VARIE / VARIOUS APPLICATIONS	DENT -	W: 10mm L: 1450mm
LEMAVX101475L 81968200046	MAN D 0834/D 2865 - F90/L2000	DENT -	W: 10mm L: 1475mm
LEMAVX101475L 5000132350	RENAULT E7J - MEGANE	DENT -	W: 10mm L: 1475mm
LEMAVX101500L 06580731411 06580731412	MAN D 2876 - E2000	DENT -	W: 10mm L: 1500mm

DENT: Dentata - Cogged | **DENT-2:** Dentata accoppiata - Cogged 2 ribs | **DENT-3:** Dentata tripla - Cogged 3 ribs | **MULT:** Multipla - Kraftbands
LISCIA: Non dentata - Not cogged | **A:** Alternatore - Alternator | **C:** Condizionatore - Air conditioner | **CPR:** Compressore - Compressor | **D:** Distribu-
zione - Timing system | **P:** Pompa acqua - Water pump | **V:** Ventilatore - Fan | **PS:** Idroguida - Power steering | **HP:** Pompa idraulica - Hydraulic pump

References	Car maker	Type	Dimensions
LEMAVX101525L 4756335	IVECO 190.35 H-190.35 HT-260.35 H-330.35 H3/HW3-330.35 H/HT/HW	DENT A - P	W: 10mm L: 1525mm
LEMAVX101525L 6580721422	MAN F2000-M90	DENT -	W: 10mm L: 1525mm
LEMAVX101550L 4788552	IVECO 190/220/240.38 TRU-190.42 TURBOSTAR	DENT P - V	W: 10mm L: 1550mm
LEMAVX101550L 6580731432	MAN BUS SG192	DENT A - C	W: 10mm L: 1550mm
LEMAVX101550L 5000678484	RENAULT R310/330/340/350/365	DENT P	W: 10mm L: 1550mm
LEMAVX101575L 5000790821	RENAULT GBH/TBH260/280-R310/340/357/365-AE380	DENT P	W: 10mm L: 1575mm
LEMAVX101650L 6580731473	MAN BUS LION'S COACH-EUROLINER	DENT C	W: 10mm L: 1650mm
LEMAVX101725L 06580731502	MAN D0826LOH15/17/19 - LION'S CLASSIC	DENT -	W: 10mm L: 1725mm
LEMAVX10625L	UNIVERSAL APPLICAZIONI VARIE / VARIOUS APPLICATIONS	DENT -	W: 10mm L: 625mm
LEMAVX10800L	UNIVERSAL APPLICAZIONI VARIE / VARIOUS APPLICATIONS	DENT -	W: 10mm L: 800mm
LEMAVX10825L	UNIVERSAL APPLICAZIONI VARIE / VARIOUS APPLICATIONS	DENT -	W: 10mm L: 825mm
LEMAVX10864L	UNIVERSAL APPLICAZIONI VARIE / VARIOUS APPLICATIONS	DENT -	W: 10mm L: 864mm
LEMAVX10875L 0009975992	MERCEDES OM615	DENT P - V	W: 10mm L: 875mm
LEMAVX10900L	UNIVERSAL APPLICAZIONI VARIE / VARIOUS APPLICATIONS	DENT -	W: 10mm L: 900mm
LEMAVX10913L 5001014472	RENAULT R310 (4X2-6X4)-TR/GR305-GRH/TRH305	DENT V	W: 10mm L: 913mm
LEMAVX10925L 98462373	IVECO DAILY-NEWDAILY 30/35/40.8-NEWTURBODAILY	DENT P - V	W: 10mm L: 925mm

DENT: Dentata - *Cogged* | **DENT-2:** Dentata accoppiata - *Cogged 2 ribs* | **DENT-3:** Dentata tripla - *Cogged 3 ribs* | **MULT:** Multipla - *Kraftbands*
LISCIA: Non dentata - *Not cogged* | **A:** Alternatore - *Alternator* | **C:** Condizionatore - *Air conditioner* | **CPR:** Compressore - *Compressor* | **D:** Distribu-
zione - *Timing system* | **P:** Pompa acqua - *Water pump* | **V:** Ventilatore - *Fan* | **PS:** Idroguida - *Power steering* | **HP:** Pompa idraulica - *Hydraulic pump*

References	Car maker	Type	Dimensions
LEMAVX10925L 98462373	IVECO BUS DAILY A30/32/35.8-NEWDAILY A40.8 NEWTURBODAILY A40.10/A45.12/A49.10 / NEWDAILY(96) A40.10/A40.12/A45.10/A45.12/A49.10	DENT P - V	W: 10mm L: 925mm
LEMAVX10925L 4758123	FIAT NUOVO DUCATO DS. R.90 (1990-1994)-NUOVO DUCATO 4X4	DENT P - V	W: 10mm L: 925mm
LEMAVX10935L 5001821740	RENAULT R310 (4X2-6X4)-TR/GR280/305-GRH/TRH305-B70/80/90/110/120	DENT V	W: 10mm L: 935mm
LEMAVX10940L 0049978792	MERCEDES M115-OM615-OM616	DENT A - V	W: 10mm L: 940mm
LEMAVX10940L 973538	VOLVO F16 (55A)	DENT A	W: 10mm L: 940mm
LEMAVX10950L 5000816443	RENAULT GR/TR280-GBH260/280-B80/110/120	DENT P - V	W: 10mm L: 950mm
LEMAVX10950L 973539 973483	VOLVO F16 (80A)	DENT A	W: 10mm L: 950mm
LEMAVX10975L 2991701	IVECO BUS A90.13-A90.14-315.13-316.13	DENT C	W: 10mm L: 975mm
LEMAVX10975L 0679733	DAF F2300-F2500	DENT -	W: 10mm L: 975mm
LEMAVX10975L 2991701	IVECO 190.30 AHT-200.32 AHW-200.32 AHT-160.19 ANW - 95/109.14 3°S-645/650/662N1/N2	DENT C	W: 10mm L: 975mm
LEMAVX10975L 0069979292	MERCEDES M110	DENT A - V	W: 10mm L: 975mm
LEMAVX10975L 6580731201	MAN A90.13-A90.14-315.13-316.13	DENT -	W: 10mm L: 975mm
LEMAVX10990L 98473700	IVECO BUS 315.17 TURBO	DENT A	W: 10mm L: 990mm
LEMAVX10990L 42534779	IVECO 79/80/90/100.13-79.14 3°S-80/90/100/110NC-110.14-115/135.14/17 1°S	DENT C	W: 10mm L: 990mm
LEMAVX131000L 1425709	DAF 85CF-CF85-95XF BUS DB250-KD	DENT C - P	W: 13mm L: 1000mm
LEMAVX131000L 4749445	IVECO 190PT26-190.26 H/HT/HW-260.26 H/HT/HW-330.26H	DENT P - V	W: 13mm L: 1000mm

DENT: Dentata - Cogged | **DENT-2:** Dentata accoppiata - Cogged 2 ribs | **DENT-3:** Dentata tripla - Cogged 3 ribs | **MULT:** Multipla - Kraftbands
LISCIA: Non dentata - Not cogged | **A:** Alternatore - Alternator | **C:** Condizionatore - Air conditioner | **CPR:** Compressore - Compressor | **D:** Distribu-
zione - Timing system | **P:** Pompa acqua - Water pump | **V:** Ventilatore - Fan | **PS:** Idroguida - Power steering | **HP:** Pompa idraulica - Hydraulic pump

References	Car maker	Type	Dimensions
LEMAVX131000L 0059976892	MERCEDES 209D-309D-409D	DENT A	W: 13mm L: 1000mm
LEMAVX131000L 6580722212	MAN 85CF-CF85-95XF BUS DB250-KD	DENT A	W: 13mm L: 1000mm
LEMAVX131015L	UNIVERSAL APPLICAZIONI VARIE / VARIOUS APPLICATIONS	DENT -	W: 13mm L: 1015mm
LEMAVX131025L 0067667	DAF 1160 AVM-85CF-CF85-95XF-F2100-F95 BUS DB250-KD	DENT A - C - P	W: 13mm L: 1025mm
LEMAVX131025L 4645910 4732574	IVECO 190.26/30 H 1°S-260/330.30 H 1°S	DENT P - V	W: 13mm L: 1025mm
LEMAVX131025L 0079970392 0099976992	MERCEDES 207D-307D-309D-310D-407D-O 301 OM364-OM366	DENT A - V	W: 13mm L: 1025mm
LEMAVX131025L 6580722222	MAN 1160 AVM-85CF-CF85-95XF-F2100-F95 BUS DB250-KD	DENT -	W: 13mm L: 1025mm
LEMAVX131025L 967111	VOLVO F6S	DENT C	W: 13mm L: 1025mm
LEMAVX131040L 500385852	IVECO BUS EURORIDER .35/38	DENT A	W: 13mm L: 1040mm
LEMAVX131050L 0296961	DAF F2500-F2800	DENT A	W: 13mm L: 1050mm
LEMAVX131050L 98459455	IVECO BUS EUROPOLIS 200E.8.13/200E.9.15	DENT A	W: 13mm L: 1050mm
LEMAVX131050L 42520250 98459455	IVECO 160/190/260.30AH/AHT/AHW-300.32/34AH-330.30AN/ANW EUROTECH-EUROSTAR-EUROTRAKKER-E31/E37/E42/E47	DENT A - C	W: 13mm L: 1050mm
LEMAVX131050L 139978092	MERCEDES O 301-OM906 LA-OM926 LA	DENT A - P	W: 13mm L: 1050mm
LEMAVX131050L 6580722231	MAN F2500-F2800	DENT -	W: 13mm L: 1050mm
LEMAVX131050L 966387 - 966388	VOLVO BUS B10MF10-F12-F16-FL6-FL7-FL10 N10-N12-NL10-NL12	DENT A - C	W: 13mm L: 1050mm
LEMAVX131060L 99441755	IVECO BUS 200E.8.17-203E.9.26	DENT C	W: 13mm L: 1060mm

DENT: Dentata - *Cogged* | **DENT-2:** Dentata accoppiata - *Cogged 2 ribs* | **DENT-3:** Dentata tripla - *Cogged 3 ribs* | **MULT:** Multipla - *Kraftbands*
LISCIA: Non dentata - *Not cogged* | **A:** Alternatore - *Alternator* | **C:** Condizionatore - *Air conditioner* | **CPR:** Compressore - *Compressor* | **D:** Distribu-
zione - *Timing system* | **P:** Pompa acqua - *Water pump* | **V:** Ventilatore - *Fan* | **PS:** Idroguida - *Power steering* | **HP:** Pompa idraulica - *Hydraulic pump*

References	Car maker	Type	Dimensions
LEMAVX131075L 0894415 1289208	DAF F95 500-FT95 500-95XF-95XF 530 BUS KD-MB230	DENT A - C	W: 13mm L: 1075mm
LEMAVX131075L 1119276 2418962	IVECO 110.16ANW-120.13AN/ANW-120.16ANW-130.13A/AH/AN-130.16A/ AH/AT-15	DENT C	W: 13mm L: 1075mm
LEMAVX131075L 5001014471	RENAULT GR/TR350-GRH/TRH350-R360/370/390/420	DENT V	W: 13mm L: 1075mm
LEMAVX131075L 967184	VOLVO FL7	DENT V	W: 13mm L: 1075mm
LEMAVX131100L 1254890	DAF BUS MB230	DENT A	W: 13mm L: 1100mm
LEMAVX131100L N1011001586	MAN BUS SR240	DENT V	W: 13mm L: 1100mm
LEMAVX131100L 0059971492	MERCEDES BUS O 305/307	DENT V	W: 13mm L: 1100mm
LEMAVX131100L 117209C604	NISSAN CABSTAR TL (MOT. LD23 / 11/1998-07/2001)	DENT A	W: 13mm L: 1100mm
LEMAVX131100L 5001014848	RENAULT G MANAGER-AE MAGNUM 390/430/470	DENT C	W: 13mm L: 1100mm
LEMAVX131100L 966391 966392	VOLVO F6 USA-F7 USA-FL7 NL10-NL12BUS B6F	DENT A - C - V	W: 13mm L: 1100mm
LEMAVX131125L 6580732262	MAN E 2866 - LION'S CITY/COACH/COMFORT	DENT -	W: 13mm L: 1125mm
LEMAVX131125L 11750G9600	NISSAN ATLEON ECO-T (MOT. B440TI / 1997-2000) ATLEON TK 140 (MOT. B440TI / 2000-2006)	DENT PS	W: 13mm L: 1125mm
LEMAVX131125L 5000789953	RENAULT SG2-SG3-SG4-R-AE MAGNUM 390/430/470	DENT A - P	W: 13mm L: 1125mm
LEMAVX131125L 966395	VOLVO FL6	DENT C	W: 13mm L: 1125mm
LEMAVX131140L 61584981	IVECO BUS APPLICAZIONI VARIE / VARIOUS APPLICATIONS	DENT -	W: 13mm L: 1140mm
LEMAVX131150L 0067668	DAF 85CF	DENT -	W: 13mm L: 1150mm

DENT: Dentata - Cogged | **DENT-2:** Dentata accoppiata - Cogged 2 ribs | **DENT-3:** Dentata tripla - Cogged 3 ribs | **MULT:** Multipla - Kraftbands
LISCIA: Non dentata - Not cogged | **A:** Alternatore - Alternator | **C:** Condizionatore - Air conditioner | **CPR:** Compressore - Compressor | **D:** Distribu-
zione - Timing system | **P:** Pompa acqua - Water pump | **V:** Ventilatore - Fan | **PS:** Idroguida - Power steering | **HP:** Pompa idraulica - Hydraulic pump

References	Car maker	Type	Dimensions
LEMAVX131150L 98466498	IVECO EUROTECH 170E23-190E24/E27-150/170/320E27-180E24	DENT C	W: 13mm L: 1150mm
LEMAVX131150L 6580732272	MAN BUS LION'S COACH - NG/NL/NÜ - SD/SG/SL/SÜ - ÜL	DENT A	W: 13mm L: 1150mm
LEMAVX131150L 0039970592	MERCEDES BUS O 303/305/307/405	DENT A	W: 13mm L: 1150mm
LEMAVX131150L 1172069T01 11950G2401	NISSAN ATLEON TK (MOT. BD30TI / ? 06/2003) - TRADE (MOT. BD30TI / ? 2001) ATLEON ECO-T LTR (MOT. BD30 / 07/93?)CABSTAR TL/TLR (MOT. TD27T / 06/1999-12/2003)	DENT A - PS - V	W: 13mm L: 1150mm
LEMAVX131150L 5001014573	RENAULT R310/357/365	DENT C	W: 13mm L: 1150mm
LEMAVX131150L 814192	SCANIA R143 SENZA CONDIZIONATORE / WITHOUT AIR CONDITIONING (DSC14 03)	DENT A - V	W: 13mm L: 1150mm
LEMAVX131150L 966846	VOLVO FL10	DENT V	W: 13mm L: 1150mm
LEMAVX131175L 97107178	IVECO BUS 490.18.29 E2-590.18.29 E2	DENT A	W: 13mm L: 1175mm
LEMAVX131175L D032572	MENARINI BUS 490.18.29 E2-590.18.29 E2	DENT -	W: 13mm L: 1175mm
LEMAVX131175L 0192144	DAF 490.18.29 E2-590.18.29 E2	DENT -	W: 13mm L: 1175mm
LEMAVX131175L 0069972092 0069972192	MERCEDES O 3170 303-O 305 G	DENT V	W: 13mm L: 1175mm
LEMAVX131175L 06580732282	MAN 490.18.29 E2-590.18.29 E2	DENT -	W: 13mm L: 1175mm
LEMAVX131175L 5000686547	RENAULT TR/GR305-TRH/GRH305-R310/330/340/365-PA200/210 PS150/160-MACK MS200//250/300-GBH260/280	DENT V	W: 13mm L: 1175mm
LEMAVX131175L 814193	SCANIA R143 SENZA CONDIZIONATORE / WITHOUT AIR CONDITIONING (DSC14 06)	DENT A	W: 13mm L: 1175mm
LEMAVX131175L 966847	VOLVO FL10	DENT C - P - V	W: 13mm L: 1175mm
LEMAVX131175L 4766718100	SETRA BUS	DENT -	W: 13mm L: 1175mm

DENT: Dentata - Cogged | **DENT-2:** Dentata accoppiata - Cogged 2 ribs | **DENT-3:** Dentata tripla - Cogged 3 ribs | **MULT:** Multipla - Kraftbands
LISCIA: Non dentata - Not cogged | **A:** Alternatore - Alternator | **C:** Condizionatore - Air conditioner | **CPR:** Compressore - Compressor | **D:** Distribu-
 zione - Timing system | **P:** Pompa acqua - Water pump | **V:** Ventilatore - Fan | **PS:** Idroguida - Power steering | **HP:** Pompa idraulica - Hydraulic pump

References	Car maker	Type	Dimensions
LEMAVX131200L 500370647	IVECO 190.35 H/HT-260.35 H-330.35 H3/HW3-330.35H/HT/HW-330.36EUROCARGO E23- EUROTECH/STAR E42-EUROTRAKKER E31/37/42	DENT P - V	W: 13mm L: 1200mm
LEMAVX131200L 0069979592	MERCEDES O 303-O 364-O 405-O 408-OH 1113-OH1316	DENT V	W: 13mm L: 1200mm
LEMAVX131200L 5010553922	RENAULT TR/GR280/305-GRH/TRH305-MIDLINER-R310/330/340/365 PS150/160-MACK CS/MS200/250/300-G200/210/230TI PREMIUM PR-MIDLUM	DENT C	W: 13mm L: 1200mm
LEMAVX131200L 6580732292	MAN D0226MK/MKF-BUS UL772	DENT HP	W: 13mm L: 1200mm
LEMAVX131200L 814194	SCANIA G112-P112-R112	DENT A - C - V	W: 13mm L: 1200mm
LEMAVX131200L 966393	VOLVO F4-F10-FL10-N10-NL10-NH12	DENT C - V	W: 13mm L: 1200mm
LEMAVX131200L 966394	VOLVO F10-F12-N10	DENT P	W: 13mm L: 1200mm
LEMAVX131225L 0215523 1333364	DAF F1100-LF45-85CF-95XF	DENT A - P	W: 13mm L: 1225mm
LEMAVX131225L 4739632 4763649	IVECO BUS 470.20 (1°T)-570.20 (1°T)-670.20 (1°T)470/570/670.20 (2°T) 471.20 U-EFFEUNO-571.20 S-EFFEUNO	DENT A - V	W: 13mm L: 1225mm
LEMAVX131225L 1333364 1376752	DAF 1160 AVM-85CF-95XF-F95BUS KD F2300	DENT A - P	W: 13mm L: 1225mm
LEMAVX131225L 6580732302	MAN 19.332+19.362	DENT -	W: 13mm L: 1225mm
LEMAVX131225L 5000686895	RENAULT GR/TR280/305-GRH/TRH305-R310/330/340/365 MIDLINER- PS150/160-PREMIUM-KERAX	DENT A - C	W: 13mm L: 1225mm
LEMAVX131225L 814195	SCANIA 142 1°TBUS K93	DENT A - V	W: 13mm L: 1225mm
LEMAVX131225L 966395	VOLVO FL6	DENT A - C	W: 13mm L: 1225mm
LEMAVX131235L 98436429 98465820	IVECO EUROCARGO E23-EUROFIRE E24	DENT A - P	W: 13mm L: 1235mm

DENT: Dentata - Cogged | **DENT-2:** Dentata accoppiata - Cogged 2 ribs | **DENT-3:** Dentata tripla - Cogged 3 ribs | **MULT:** Multipla - Kraftbands
LISCIA: Non dentata - Not cogged | **A:** Alternatore - Alternator | **C:** Condizionatore - Air conditioner | **CPR:** Compressore - Compressor | **D:** Distribu-
zione - Timing system | **P:** Pompa acqua - Water pump | **V:** Ventilatore - Fan | **PS:** Idroguida - Power steering | **HP:** Pompa idraulica - Hydraulic pump

References	Car maker	Type	Dimensions
LEMAVX131250L 0268448 0378724	DAF 620 AVM BUS TT2100	DENT -	W: 13mm L: 1250mm
LEMAVX131250L 6580732312	MAN 620 AVM BUS TT2100	DENT -	W: 13mm L: 1250mm
LEMAVX131250L 5000686893	RENAULT MAXTER-G MANAGER	DENT HP	W: 13mm L: 1250mm
LEMAVX131250L 967191 977317	VOLVO F7BUS B9M-B10M (115A)	DENT A - C	W: 13mm L: 1250mm
LEMAVX131275L 500390604	IVECO BUS EUROCLASS .36/43-EURORIDER.43	DENT A	W: 13mm L: 1275mm
LEMAVX131275L 0067669	DAF 60/1160 AVM-85CF-95XF-F95 BUS KD-MB230-SB3000	DENT A - V - P	W: 13mm L: 1275mm
LEMAVX131275L 4830920	IVECO 190/240/260.36 TURBOSTAR	DENT C	W: 13mm L: 1275mm
LEMAVX131275L 6580732322	MAN BUS NG272 NIEDERFLURLINK-NL202 LINIE BUS	DENT V	W: 13mm L: 1275mm
LEMAVX131275L 966396 967129	VOLVO F10-F12-N10 FE6-FL6	DENT A - P	W: 13mm L: 1275mm
LEMAVX131285L 99466947	IVECO BUS 200E.8.17-203E.9.24-203E.9.26-203E.10.26-203E.8.21 EUROPOLIS	DENT C	W: 13mm L: 1285mm
LEMAVX131285L 1324638	DAF 85CFBUS CKD-DB250-KD	DENT A - V - P	W: 13mm L: 1285mm
LEMAVX131285L 98464044	IVECO EUROTECH E42-EUROSTAR E42/47-EUROTRAKKER E31/37/42/47	DENT C	W: 13mm L: 1285mm
LEMAVX131285L 7700010200	RENAULT APPLICAZIONI VARIE / VARIOUS APPLICATIONS	DENT -	W: 13mm L: 1285mm
LEMAVX131300L 98420262 98429196	IVECO BUS 315S-200E.8.13 EUROPOLIS-200E.9.15 EUROPOLIS-370.24-370.26370SE.27/29/35-CITYCLASS 491/591.22CNG-491/591.24CNG-591.27CITYCLASS .25/29/35-CITYCLASS 491.27CNG	DENT A - C - P - V	W: 13mm L: 1300mm
LEMAVX131300L 0067670 1256081 1300098	DAF 1160 AVM-F80-F95-75CF-CF75-F75 BUS KD-SB220	DENT A - V	W: 13mm L: 1300mm

DENT: Dentata - *Cogged* | **DENT-2:** Dentata accoppiata - *Cogged 2 ribs* | **DENT-3:** Dentata tripla - *Cogged 3 ribs* | **MULT:** Multipla - *Kraftbands*
LISCIA: Non dentata - *Not cogged* | **A:** Alternatore - *Alternator* | **C:** Condizionatore - *Air conditioner* | **CPR:** Compressore - *Compressor* | **D:** Distribu-
zione - *Timing system* | **P:** Pompa acqua - *Water pump* | **V:** Ventilatore - *Fan* | **PS:** Idroguida - *Power steering* | **HP:** Pompa idraulica - *Hydraulic pump*

References	Car maker	Type	Dimensions
LEMAVX131300L 98420262 98429196	IVECO EUROCARGO E10/E12/E14/E15/E18/E21 EUROCARGO E27	DENT A - P - V	W: 13mm L: 1300mm
LEMAVX131300L 0099977692	MERCEDES 609D-709D-711D-809D-811D-1117-1120-1419-2219	DENT A - P	W: 13mm L: 1300mm
LEMAVX131300L 65807223320	MAN G 10.136-G90-M90	DENT -	W: 13mm L: 1300mm
LEMAVX131300L 814198	SCANIA R143 CON CONDIZIONATORE / WITH AIR CONDITIONING (DSC14 03)	DENT A - C - V	W: 13mm L: 1300mm
LEMAVX131300L 977319	VOLVO F6BUS B54-B10M (120A) N7	DENT A - C - HP	W: 13mm L: 1300mm
LEMAVX131310L	UNIVERSAL APPLICAZIONI VARIE / VARIOUS APPLICATIONS	DENT -	W: 13mm L: 1310mm
LEMAVX131325L 4716471 4838527	IVECO BUS 3480.18.29-370S24-370S25L-370S30-TURBCITY 480/580/680 AP160	DENT A - V	W: 13mm L: 1325mm
LEMAVX131325L 0067671 0211749	DAF 825 AVMBUS KD	DENT -	W: 13mm L: 1325mm
LEMAVX131325L 8819672	IVECO 190/240/260.48 TURBOSTAR-EUROSTAR 440E52-350S25L	DENT C	W: 13mm L: 1325mm
LEMAVX131325L 0019971592	MERCEDES 914-1114-1217-1413-1414-1417-1613-1614-1617-O 301	DENT A - P	W: 13mm L: 1325mm
LEMAVX131325L 6580790016	MAN F90-M2000	DENT -	W: 13mm L: 1325mm
LEMAVX131325L 814199	SCANIA R143 CON CONDIZIONATORE / WITH AIR CONDITIONING (DSC14 06)	DENT A - C - V	W: 13mm L: 1325mm
LEMAVX131325L 966390 966398 967194	VOLVO F10-N10BUS B58-B9M-B10M	DENT C	W: 13mm L: 1325mm
LEMAVX131350L 4819630 500344477	IVECO BUS 370S35393.29 MYWAY-393.35 MYWAY-EURORIDER .26/29/35/38	DENT A - V	W: 13mm L: 1350mm
LEMAVX131350L 0107561 0067672	DAF 615 AVM	DENT A	W: 13mm L: 1350mm

DENT: Dentata - Cogged | **DENT-2:** Dentata accoppiata - Cogged 2 ribs | **DENT-3:** Dentata tripla - Cogged 3 ribs | **MULT:** Multipla - Kraftbands
LISCIA: Non dentata - Not cogged | **A:** Alternatore - Alternator | **C:** Condizionatore - Air conditioner | **CPR:** Compressore - Compressor | **D:** Distribu-
zione - Timing system | **P:** Pompa acqua - Water pump | **V:** Ventilatore - Fan | **PS:** Idroguida - Power steering | **HP:** Pompa idraulica - Hydraulic pump

References	Car maker	Type	Dimensions
LEMAVX131350L 98429205	IVECO EUROTECH 180E24/E27-190E24/E27	DENT V	W: 13mm L: 1350mm
LEMAVX131350L 5000566546 5000686864	RENAULT GG210/230/260/290-S100-AE380 1°T-G MANAGER	DENT C - V	W: 13mm L: 1350mm
LEMAVX131350L 814200	SCANIA 113-BUS K93	DENT V	W: 13mm L: 1350mm
LEMAVX131350L 977221	VOLVO BUS B9M-B10M F10-F12FL6	DENT A - V - P	W: 13mm L: 1350mm
LEMAVX131375L 500379179	IVECO BUS 393.29 MYWAY-393.35 MYWAY-EURORIDER .26/29/35/38	DENT V	W: 13mm L: 1375mm
LEMAVX131375L 0701363	DAF 1160 AVM-F1600BUS SB220-SB3000-SBR3000	DENT A	W: 13mm L: 1375mm
LEMAVX131375L 5000681405	RENAULT G210/230/260/270/290/320/340TI-MAXTER-PREMIUM-PG280	DENT A	W: 13mm L: 1375mm
LEMAVX131375L 966702 978787	VOLVO F10-F12BUS B57-B7F-B9M-B10M-C10M	DENT HP	W: 13mm L: 1375mm
LEMAVX131400L 4843796 61318427	IVECO BUS A175.24	DENT A	W: 13mm L: 1400mm
LEMAVX131400L 0211144 1256304	DAF 615 AVM-F85	DENT C	W: 13mm L: 1400mm
LEMAVX131400L 4843796 61318427	IVECO 175.24-175.24RSU-190/240.26TRU-190/240.32GV/TRU-220.32TRU EUROTECH-EUROSTAR E30/34/38	DENT A	W: 13mm L: 1400mm
LEMAVX131400L 5000787170	RENAULT GR/TR350-GRH/TRH350-G260/290-R360/370/390/420	DENT A	W: 13mm L: 1400mm
LEMAVX131400L 977320	VOLVO BUS B9M-B10M	DENT A	W: 13mm L: 1400mm
LEMAVX131425L 4818791	IVECO BUS A55.13-370SE.27-418AC-418AL	DENT A	W: 13mm L: 1425mm
LEMAVX131425L 0067675 - 0212269	DAF 85CF F1600	DENT A - P	W: 13mm L: 1425mm

DENT: Dentata - *Cogged* | **DENT-2:** Dentata accoppiata - *Cogged 2 ribs* | **DENT-3:** Dentata tripla - *Cogged 3 ribs* | **MULT:** Multipla - *Kraftbands*
LISCIA: Non dentata - *Not cogged* | **A:** Alternatore - *Alternator* | **C:** Condizionatore - *Air conditioner* | **CPR:** Compressore - *Compressor* | **D:** Distribu-
zione - *Timing system* | **P:** Pompa acqua - *Water pump* | **V:** Ventilatore - *Fan* | **PS:** Idroguida - *Power steering* | **HP:** Pompa idraulica - *Hydraulic pump*

References	Car maker	Type	Dimensions
LEMAVX131425L 2991705 815464	IVECO 160NC-300PC-619N1P-683N-684N/NP-690N3/N4-691N/693N190.42 TURBOSTAR EUROTECH MP/MT	DENT A - C - P - V	W: 13mm L: 1425mm
LEMAVX131425L 06580732382 06580790028	MAN D2555MXF-F90 19.342-26.342BUS D2555MXUH D2556MUH/MHUH/MXUM-D2566MUH	DENT A - V	W: 13mm L: 1425mm
LEMAVX131425L 5000820750	RENAULT APPLICAZIONI VARIE / VARIOUS APPLICATIONS	DENT -	W: 13mm L: 1425mm
LEMAVX131425L 9515801 976496	VOLVO BUS B12-B12BR BUS B9M-B10M	DENT A - V	W: 13mm L: 1425mm
LEMAVX131450L 1289204 0212523	DAF 825/865 AVM-85CF-F1600-F1800-F2100-F2300-F2500-F2700 BUS DB250-KD-MB200-SB220-SB225-SB250-TB2100	DENT A - V	W: 13mm L: 1450mm
LEMAVX131450L 2991706	IVECO 160/170/180/190.26-180NC-190.30 NT-240/330.26- 300PC190/220/240/260.30-190.30 TRU-619N1-697N	DENT P - V	W: 13mm L: 1450mm
LEMAVX131450L 6580732391	MAN D2555M	DENT A	W: 13mm L: 1450mm
LEMAVX131450L 11720D8701	NISSAN ATLEON ECO-T (MOT. B440TI / 1997-2000) ATLEON TK 140 (MOT. B440TI / 2000-2006)	DENT A	W: 13mm L: 1450mm
LEMAVX131450L 5001014574	RENAULT GBH260-GBH/TBH280-GLM/TLM280	DENT A	W: 13mm L: 1450mm
LEMAVX131450L 977322	VOLVO F10-F12	DENT V	W: 13mm L: 1450mm
LEMAVX131475L 0067677	DAF 625 AVM-65CF-F1700-F65BUS KD	DENT A - V	W: 13mm L: 1475mm
LEMAVX131475L 98473728	IVECO 165.24 (SOLO PER ESTERO/NOT FOR ITALY) - 190.30 HT-190.30 HW	DENT P - V	W: 13mm L: 1475mm
LEMAVX131475L 004997599	MERCEDES 1424-1626-1632-1719-1919-1926-1932-2026-2224-2632	DENT A - P	W: 13mm L: 1475mm
LEMAVX131475L 6580422240	MAN 19.332-19.362-BUS D2556MUH	DENT A - C	W: 13mm L: 1475mm
LEMAVX131475L 966605	VOLVO N12BUS B58-B9M-B10M	DENT V	W: 13mm L: 1475mm

DENT: Dentata - Cogged | **DENT-2:** Dentata accoppiata - Cogged 2 ribs | **DENT-3:** Dentata tripla - Cogged 3 ribs | **MULT:** Multipla - Kraftbands
LISCIA: Non dentata - Not cogged | **A:** Alternatore - Alternator | **C:** Condizionatore - Air conditioner | **CPR:** Compressore - Compressor | **D:** Distribu-
zione - Timing system | **P:** Pompa acqua - Water pump | **V:** Ventilatore - Fan | **PS:** Idroguida - Power steering | **HP:** Pompa idraulica - Hydraulic pump

References	Car maker	Type	Dimensions
LEMAVX131500L 0068229	DAF 620/825 AVM-F1100-F1300-F1700-F1900BUS KD	DENT A - V	W: 13mm L: 1500mm
LEMAVX131500L 967201 967202	VOLVO N12-NL12BUS B10M (120A)	DENT A	W: 13mm L: 1500mm
LEMAVX131525L 1265398	DAF F1600-1160 AVM-SB3000	DENT A	W: 13mm L: 1525mm
LEMAVX131525L 61315876	IVECO BUS 370S24	DENT A	W: 13mm L: 1525mm
LEMAVX131525L 500349860	IVECO 190/240/260.48 TURBOSTAR-190/260/400/440E52 EUROSTAR	DENT P	W: 13mm L: 1525mm
LEMAVX131525L 0059972492	MERCEDES 1626-1635-1638-1928-1935-1938-2224-2235-2536-3328-3336	DENT A - P	W: 13mm L: 1525mm
LEMAVX131525L 6580732422	MAN D2530MXF-D2565MF-D2566MK/MKF/MTF	DENT A	W: 13mm L: 1525mm
LEMAVX131525L 814207	SCANIA BUS K93-L113	DENT P	W: 13mm L: 1525mm
LEMAVX131525L 9515805	VOLVO B10B-B10BLE	DENT A - V	W: 13mm L: 1525mm
LEMAVX131550L 500385541	IVECO BUS EURORIDER.43	DENT P - V	W: 13mm L: 1550mm
LEMAVX131550L 0067679 0360860	DAF BUS KD-SB201	DENT -	W: 13mm L: 1550mm
LEMAVX131550L 98459452	IVECO 190.48-240.48-260.48 TURBOSTAREUROSTAR 190/240/260/400/440 E52	DENT P	W: 13mm L: 1550mm
LEMAVX131550L 6580722433	MAN M90	DENT A	W: 13mm L: 1550mm
LEMAVX131550L 5000789954 5000786359	RENAULT CBH/CLM280/320/340/385 AE MAGNUM 390/430/470	DENT A - P - V	W: 13mm L: 1550mm
LEMAVX131550L 967204 967205 967206	VOLVO N10-NL10-NL12 BUS B9M-B10M	DENT C - V	W: 13mm L: 1550mm

DENT: Dentata - *Cogged* | **DENT-2:** Dentata accoppiata - *Cogged 2 ribs* | **DENT-3:** Dentata tripla - *Cogged 3 ribs* | **MULT:** Multipla - *Kraftbands*
LISCIA: Non dentata - *Not cogged* | **A:** Alternatore - *Alternator* | **C:** Condizionatore - *Air conditioner* | **CPR:** Compressore - *Compressor* | **D:** Distribu-
zione - *Timing system* | **P:** Pompa acqua - *Water pump* | **V:** Ventilatore - *Fan* | **PS:** Idroguida - *Power steering* | **HP:** Pompa idraulica - *Hydraulic pump*

References	Car maker	Type	Dimensions
LEMAVX131575L 4724877	IVECO BUS 370.20.00	DENT V	W: 13mm L: 1575mm
LEMAVX131575L 0067680	DAF 1160 AVM	DENT -	W: 13mm L: 1575mm
LEMAVX131575L 0059972792 0059972892	MERCEDES 370.20.00	DENT P	W: 13mm L: 1575mm
LEMAVX131575L 6580722442	MAN M90	DENT V	W: 13mm L: 1575mm
LEMAVX131575L 814209	SCANIA 113	DENT A - V	W: 13mm L: 1575mm
LEMAVX131600L 4776403	IVECO BUS 370.24.00	DENT V	W: 13mm L: 1600mm
LEMAVX131600L 0067681 0243947	DAF 825/1160 AVM-F1800-F2100-F2300-F2500 BUS CKD-DM-KD-TB2100-TT2100	DENT A	W: 13mm L: 1600mm
LEMAVX131600L 6580722452	MAN M90	DENT -	W: 13mm L: 1600mm
LEMAVX131600L 814210	SCANIA 82-112-113 SENZA CONDIZIONATORE / WITHOUT AIR CONDITIONING	DENT A - V	W: 13mm L: 1600mm
LEMAVX131625L 0067682	DAF 825 AVM-F1800-F2100-F2300-F2500 BUS CKD-DM-KD-TB2100-TT2100	DENT A	W: 13mm L: 1625mm
LEMAVX131625L 6580732452	MAN M90	DENT V	W: 13mm L: 1625mm
LEMAVX131625L 5000954214 5001822405	RENAULT APPLICAZIONI VARIE / VARIOUS APPLICATIONS	DENT -	W: 13mm L: 1625mm
LEMAVX131625L 814211	SCANIA 112-113-94	DENT A	W: 13mm L: 1625mm
LEMAVX131625L 4766777100	SETRA BUS	DENT -	W: 13mm L: 1625mm
LEMAVX131650L 0067683 0220048	DAF F2800	DENT A	W: 13mm L: 1650mm

DENT: Dentata - Cogged | **DENT-2:** Dentata accoppiata - Cogged 2 ribs | **DENT-3:** Dentata tripla - Cogged 3 ribs | **MULT:** Multipla - Kraftbands
LISCIA: Non dentata - Not cogged | **A:** Alternatore - Alternator | **C:** Condizionatore - Air conditioner | **CPR:** Compressore - Compressor | **D:** Distribu-
zione - Timing system | **P:** Pompa acqua - Water pump | **V:** Ventilatore - Fan | **PS:** Idroguida - Power steering | **HP:** Pompa idraulica - Hydraulic pump

References	Car maker	Type	Dimensions
LEMAVX131650L 4800089	IVECO EUROTECH 240E25	DENT A	W: 13mm L: 1650mm
LEMAVX131650L 958381	VOLVO B12	DENT A	W: 13mm L: 1650mm
LEMAVX131675L 500379181	IVECO BUS 393.29 MYWAY-393.35 MYWAY-EURORIDER .26/29/35/38	DENT V	W: 13mm L: 1675mm
LEMAVX131675L 0067684 0238670	DAF 1160 AVM-F2100-F2800-F2900-F3200-F3300-F3600-N2800 BUS CKD-DM-KD-KD 1160	DENT A	W: 13mm L: 1675mm
LEMAVX131675L 500379181	IVECO 393.29 MYWAY-393.35 MYWAY-EURORIDER .26/29/35/38	DENT -	W: 13mm L: 1675mm
LEMAVX131675L 0069970692	MERCEDES 393.29 MYWAY-393.35 MYWAY-EURORIDER .26/29/35/38	DENT A - P - V	W: 13mm L: 1675mm
LEMAVX131675L 6580722482	MAN 393.29 MYWAY-393.35 MYWAY-EURORIDER .26/29/35/38	DENT -	W: 13mm L: 1675mm
LEMAVX131685L	UNIVERSAL APPLICAZIONI VARIE / VARIOUS APPLICATIONS	DENT -	W: 13mm L: 1685mm
LEMAVX131700L 0067685 0237839	DAF 865/1160 AVMBUS KD	DENT A - V	W: 13mm L: 1700mm
LEMAVX131700L 98456206 98430540	IVECO 190/220.36 TURBOTECH-190/240/260.36 TURBOSTAR	DENT A	W: 13mm L: 1700mm
LEMAVX131700L 1420909	SCANIA 82-112-11394 SENZA CONDIZIONATORE / WITHOUT AIR CONDITIONING	DENT A - P	W: 13mm L: 1700mm
LEMAVX131700L 958383	VOLVO BUS B12	DENT A	W: 13mm L: 1700mm
LEMAVX131725L 500344478	IVECO BUS 393.29 MYWAY-393.35 MYWA EURORIDER .26/29/35/38 470.20-570.20-670.20 1°T	DENT V	W: 13mm L: 1725mm
LEMAVX131725L 0049973092	MERCEDES O 307	DENT V	W: 13mm L: 1725mm
LEMAVX131725L 814215	SCANIA 3-SERIES	DENT C	W: 13mm L: 1725mm

DENT: Dentata - Cogged | **DENT-2:** Dentata accoppiata - Cogged 2 ribs | **DENT-3:** Dentata tripla - Cogged 3 ribs | **MULT:** Multipla - Kraftbands
LISCIA: Non dentata - Not cogged | **A:** Alternatore - Alternator | **C:** Condizionatore - Air conditioner | **CPR:** Compressore - Compressor | **D:** Distribu-
zione - Timing system | **P:** Pompa acqua - Water pump | **V:** Ventilatore - Fan | **PS:** Idroguida - Power steering | **HP:** Pompa idraulica - Hydraulic pump

References	Car maker	Type	Dimensions
LEMAVX131725L 6580722501	MAN 393.29 MYWAY-393.35 MYWAY EURORIDER .26/29/35/38 470.20-570.20-670.20 1°T	DENT -	W: 13mm L: 1725mm
LEMAVX131775L 6580732522	MAN D 0826 LUH 01 - NG 262/272	DENT -	W: 13mm L: 1775mm
LEMAVX131775L 9518400	VOLVO BUS B10B-B10BLE	DENT A	W: 13mm L: 1775mm
LEMAVX131775L 4766881100	SETRA BUS	DENT V	W: 13mm L: 1775mm
LEMAVX131800L 4772213 4829322	IVECO APPLICAZIONI VARIE / VARIOUS APPLICATIONS	DENT -	W: 13mm L: 1800mm
LEMAVX131800L 0059973692	MERCEDES BUS O 307-UNIMOG U5000	DENT V	W: 13mm L: 1800mm
LEMAVX131800L 4766783100	SETRA BUS	DENT V	W: 13mm L: 1800mm
LEMAVX131825L 4822100	IVECO BUS AP160	DENT P - V	W: 13mm L: 1825mm
LEMAVX131825L 4727032	IVECO APPLICAZIONI VARIE / VARIOUS APPLICATIONS	DENT -	W: 13mm L: 1825mm
LEMAVX131825L 6580732542	MAN F90	DENT A	W: 13mm L: 1825mm
LEMAVX131825L 814219	SCANIA 92-93	DENT A - P - V	W: 13mm L: 1825mm
LEMAVX131825L 4766784002	SETRA BUS	DENT A - P - V	W: 13mm L: 1825mm
LEMAVX131850L 6580732553	MAN APPLICAZIONI VARIE / VARIOUS APPLICATIONS	DENT A - P - V	W: 13mm L: 1850mm
LEMAVX131850L 0089972992	MERCEDES MK 1824/2524 L	DENT A - P - V	W: 13mm L: 1850mm
LEMAVX131850L 4766884100	SETRA BUS	DENT A - P - V	W: 13mm L: 1850mm
LEMAVX131900L 1420908	SCANIA 94 CON CONDIZIONATORE / WITH AIR CONDITIONING	DENT A - C - P	W: 13mm L: 1900mm

DENT: Dentata - Cogged | **DENT-2:** Dentata accoppiata - Cogged 2 ribs | **DENT-3:** Dentata tripla - Cogged 3 ribs | **MULT:** Multipla - Kraftbands
LISCIA: Non dentata - Not cogged | **A:** Alternatore - Alternator | **C:** Condizionatore - Air conditioner | **CPR:** Compressore - Compressor | **D:** Distribu-
zione - Timing system | **P:** Pompa acqua - Water pump | **V:** Ventilatore - Fan | **PS:** Idroguida - Power steering | **HP:** Pompa idraulica - Hydraulic pump

References	Car maker	Type	Dimensions
LEMAVX131900L 9518588	VOLVO BUS B10B-B10BLE	DENT A	W: 13mm L: 1900mm
LEMAVX131950L 0079926492 0079926592	MERCEDES BUS O 330	DENT V	W: 13mm L: 1950mm
LEMAVX131975L 5000793621	RENAULT APPLICAZIONI VARIE / VARIOUS APPLICATIONS	DENT -	W: 13mm L: 1975mm
LEMAVX13675L	UNIVERSAL APPLICAZIONI VARIE / VARIOUS APPLICATIONS	DENT -	W: 13mm L: 675mm
LEMAVX13700L	UNIVERSAL APPLICAZIONI VARIE / VARIOUS APPLICATIONS	DENT -	W: 13mm L: 700mm
LEMAVX13825L	UNIVERSAL APPLICAZIONI VARIE / VARIOUS APPLICATIONS	DENT -	W: 13mm L: 825mm
LEMAVX13850L 117209C603	NISSAN CABSTAR TL (MOT. LD23 / 11/1998-07/2001)	DENT PS	W: 13mm L: 850mm
LEMAVX13875L 99436608	IVECO BUS NEWDAILY A40.8/A40.10/A45.10/A45.12/A49.10	DENT C	W: 13mm L: 875mm
LEMAVX13875L 99436608	IVECO NEWTURBODAILY 35/49.10-TURBODAILY 35/49.12 (MOT. 1927816 ?)	DENT C	W: 13mm L: 875mm
LEMAVX13900L 0059970892 0069977492	MERCEDES OM366A UNIMOG	DENT A	W: 13mm L: 900mm
LEMAVX13900L 6580732172	MAN OM366A UNIMOG	DENT -	W: 13mm L: 900mm
LEMAVX13900L 4766704100	SETRA BUS	DENT -	W: 13mm L: 900mm
LEMAVX13918L 5000816970	RENAULT GB131-S130/150TI	DENT CPR	W: 13mm L: 918mm
LEMAVX13925L 0049979392	MERCEDES MK SERIES - NG SERIES - LK/LN2 SERIES - T2/LN1 SERIES UNIMOG	DENT C - CPR	W: 13mm L: 925mm
LEMAVX13925L 119209X200	NISSAN ATLEON TK (MOT. BD30TI) - CABSTAR TLR (MOT. BD30TI / 06/2003 ?) CABSTAR TL/TLR (MOT. TD27T / 06/1999-12/2003) - TRADE	DENT C - V	W: 13mm L: 925mm
LEMAVX13925L 23223139	RENAULT MIDLINER	DENT C - CPR	W: 13mm L: 925mm

DENT: Dentata - Cogged | **DENT-2:** Dentata accoppiata - Cogged 2 ribs | **DENT-3:** Dentata tripla - Cogged 3 ribs | **MULT:** Multipla - Kraftbands
LISCIA: Non dentata - Not cogged | **A:** Alternatore - Alternator | **C:** Condizionatore - Air conditioner | **CPR:** Compressore - Compressor | **D:** Distribu-
 zione - Timing system | **P:** Pompa acqua - Water pump | **V:** Ventilatore - Fan | **PS:** Idroguida - Power steering | **HP:** Pompa idraulica - Hydraulic pump

References	Car maker	Type	Dimensions
LEMAVX13925L 4767704100	SETRA BUS	DENT C	W: 13mm L: 925mm
LEMAVX13950L 0239484	DAF BUS	DENT A - C	W: 13mm L: 950mm
LEMAVX13950L 1161989 98465812	IVECO 160.23 AH/AHW-190.20 ANT-190/260.25 TT-260.23 AH/AHB260.32 AH-EUROCARGO	DENT A - C	W: 13mm L: 950mm
LEMAVX13960L 0139978292	MERCEDES TRAVEGO-AXOR	DENT C	W: 13mm L: 960mm
LEMAVX13975L 6580722201	MAN APPLICAZIONI VARIE / VARIOUS APPLICATIONS	DENT -	W: 13mm L: 975mm
LEMAVX13975L 0231296	DAF BUS	DENT C	W: 13mm L: 975mm
LEMAVX13975L 2419104 98465813	IVECO BUS EUROCARGO 85E18-95E18	DENT C	W: 13mm L: 975mm
LEMAVX13975L 2419104 98465813	IVECO 160.19/23 ANW-170.23 ANW-220.32 AHTM-260.32AHM/AHW-330.32AN/ANW EUROCARGO E10-E12-E15-E18-E21-E23	DENT C	W: 13mm L: 975mm
LEMAVX13975L 0069976992 0119973192	MERCEDES 1013-1017-1213-1217-1413-1417-1613-1617UNIMOG	DENT PS	W: 13mm L: 975mm
LEMAVX13975L 979631	VOLVO B 230 - 240/740	DENT C	W: 13mm L: 975mm
LEMAVX151860L 8037640	IVECO BUS BUS CITYCLASS .31 (MOT. 8469.41S)	DENT -	W: 15mm L: 1860mm
LEMAVX172070L 5006206427	IVECO BUS 399.35 MYWAY (CURSOR) (VERS. CON SPEC. DI PRIMO IMPIANTO/1ST EQUIPMENT SPEC. IVECO)	DENT C	W: 17mm L: 2070mm
LEM2- AVX132490L 20581953	VOLVO BUS B6R-B7R	DENT-2 V	W: 13mm L: 2490mm
LEMBX171040L 500387663	IVECO BUS 200E.8.17-203E.9.24-203E.9.26 E4-203E.9.26-203E.10.26203E.8.21 EUROPOLIS	DENT HP	W: 17mm L: 1040mm
LEMBX171220L 500301260	IVECO EUROTECH E42-EUROSTAR E42/E47-EUROTRAKKER E31/E37/E42/E47	DENT P	W: 17mm L: 1220mm

DENT: Dentata - Cogged | **DENT-2:** Dentata accoppiata - Cogged 2 ribs | **DENT-3:** Dentata tripla - Cogged 3 ribs | **MULT:** Multipla - Kraftbands
LISCIA: Non dentata - Not cogged | **A:** Alternatore - Alternator | **C:** Condizionatore - Air conditioner | **CPR:** Compressore - Compressor | **D:** Distribu-
zione - Timing system | **P:** Pompa acqua - Water pump | **V:** Ventilatore - Fan | **PS:** Idroguida - Power steering | **HP:** Pompa idraulica - Hydraulic pump

References	Car maker	Type	Dimensions
LEMBX171300L 500368258	IVECO EUROCARGO 80E15-80E18-85E18-95E18-100E18	DENT P - V	W: 17mm L: 1300mm
LEMBX171300L 98473748 500368258	IVECO BUS EUROCARGO 85E18-95E18	DENT P - V	W: 17mm L: 1300mm
LEMXPB1250L 8010001583MO	MENARINI BUS APPLICAZIONI VARIE / VARIOUS APPLICATIONS	XPB V	W: 16,3mm L: 1250mm
LEMXPB1250L 8010001583MO	IVECO BUS	XPB V	W: 16,3mm L: 1250mm
LEMXPB1320L N1011001719	MAN APPLICAZIONI VARIE / VARIOUS APPLICATIONS	XPB C	W: 16,3mm L: 1320mm
LEMXPB1320L 5010072338	RENAULT NEOPLAN	XPB C	W: 16,3mm L: 1320mm
LEMXPB1400L 500369361	IVECO BUS BUS	XPB -	W: 16,3mm L: 1400mm
LEMXPB1450L 81968206017	MAN APPLICAZIONI VARIE / VARIOUS APPLICATIONS	XPB CPR	W: 16,3mm L: 1450mm
LEMXPB1500L 0039970092	MERCEDES 1113-1213-1313-1317-1413-1417-1617-1817-1819 (MOT. 0M360)	XPB CPR	W: 16,3mm L: 1500mm
LEMXPB1500L 6580590206	MAN BUS NG 262-NG 272	XPB CPR	W: 16,3mm L: 1500mm
LEMXPB1500L 5010128087	RENAULT BUS	XPB CPR	W: 16,3mm L: 1500mm
LEMXPB1500L 47680050040	SETRA BUS	XPB CPR	W: 16,3mm L: 1500mm
LEMXPB1590L	UNIVERSAL APPLICAZIONI VARIE / VARIOUS APPLICATIONS	XPB -	W: 16,3mm L: 1590mm
LEMXPB1600L 8010001582MO	IVECO BUS	XPB C	W: 16,3mm L: 1600mm
LEMXPB1650L 5801894908	IVECO BUS BUS URBANWAY E6-GX SERIES E6	XPB C	W: 16,3mm L: 1650mm
LEMXPB1700L D054349	MENARINI BUS APPLICAZIONI VARIE / VARIOUS APPLICATIONS	XPB -	W: 16,3mm L: 1700mm

DENT: Dentata - Cogged | **DENT-2:** Dentata accoppiata - Cogged 2 ribs | **DENT-3:** Dentata tripla - Cogged 3 ribs | **MULT:** Multipla - Kraftbands
LISCIA: Non dentata - Not cogged | **A:** Alternatore - Alternator | **C:** Condizionatore - Air conditioner | **CPR:** Compressore - Compressor | **D:** Distribu-
 zione - Timing system | **P:** Pompa acqua - Water pump | **V:** Ventilatore - Fan | **PS:** Idroguida - Power steering | **HP:** Pompa idraulica - Hydraulic pump

References	Car maker	Type	Dimensions
LEMXPB1700L 71201370MO	IVECO BUS BUS	XPB -	W: 16,3mm L: 1700mm
LEMXPB1800L 500369360	IVECO BUS BUS	XPB -	W: 16,3mm L: 1800mm
LEMXPB1970L 5802257374	IVECO BUS IRISBUS ARWAY E4-IRISBUS CROSSWAY-IRISBUS RECREO	XPB C	W: 16,3mm L: 1970mm
LEMXPB2150L 500392569	IVECO BUS EUROCLASS .36/43/HD	XPB C	W: 16,3mm L: 2150mm
LEMXPB2150L 81968200044	MAN EUROCLASS .36/43/HD	XPB C	W: 16,3mm L: 2150mm
LEMXPB2150L 5010103889	RENAULT EUROCLASS .36/43/HD	XPB C	W: 16,3mm L: 2150mm
LEMXPB2240L 88968206004	MAN APPLICAZIONI VARIE / VARIOUS APPLICATIONS	XPB C	W: 16,3mm L: 2240mm
LEMXPB2240L 0089975492	MERCEDES CONDIZIONATORI APPLICATI SU/AIR CONDITIONER FITTED ON SUETRAK - CONVEKTA	XPB C	W: 16,3mm L: 2240mm
LEMXPB2325L 0139974292	MERCEDES INTEGRO (KEVLAR) (VERS. CON SPEC. DI PRIMO IMPIANTO 1ST EQUIPMENT SPEC. MERCEDES)	XPB -	W: 16,3mm L: 2325mm
LEMXPB2530L 5006202480	IVECO BUS CITYCLASS .25/29/31.35 (VERS. CON SPEC. DI PRIMO IMPIANTO/1ST EQUIPMENT SPEC. IRISBUS)	XPB 4X C	W: 16,3mm L: 2530mm
LEMXPB2530L 0099974292	MERCEDES BUS(VERS. CON SPEC. DI PRIMO IMPIANTO 1ST EQUIPMENT SPEC. IRISBUS)	XPB 4X C	W: 16,3mm L: 2530mm
LEM2XPB1650L 0139971992	MERCEDES BUS O 503 LOW ENTRY-O 580 TRAVEGO	XPB-2 V	W: 36mm L: 1650mm
LEM2-HB171981L 5006219098	IVECO BUS EUROCLASS.35 CURSOR (VERS. CON SPEC. DI 1° IMPIANTO/1ST EQUIPMENT SPEC. IVECO)	KB VB C	W: 36mm L: 1981mm
LEM2XPB2000L N1011001778	MAN BUS MAN EUROLINER	XPB-2 V	W: 36mm L: 2000mm
LEM2XPB2240L 00149977092	MERCEDES MERCEDES	KBX -	W: 36mm L: 2240mm
LEM2XPB2400L 504113338	IVECO BUS CITELIS-CREALIS-HEULIEZ	XPB-2 -	W: 36mm L: 2400mm

DENT: Dentata - Cogged | **DENT-2:** Dentata accoppiata - Cogged 2 ribs | **DENT-3:** Dentata tripla - Cogged 3 ribs | **MULT:** Multipla - Kraftbands
LISCIA: Non dentata - Not cogged | **A:** Alternatore - Alternator | **C:** Condizionatore - Air conditioner | **CPR:** Compressore - Compressor | **D:** Distribu-
zione - Timing system | **P:** Pompa acqua - Water pump | **V:** Ventilatore - Fan | **PS:** Idroguida - Power steering | **HP:** Pompa idraulica - Hydraulic pump

References	Car maker	Type	Dimensions
LEM2XPB2500L 5006234769	IVECO BUS CITYCLASS .29/35 (CURSOR)-CITYCLASS 491.27CNG	XPB-2 C	W: 36mm L: 2500mm
LEM2-HB172300L	IVECO BUS APPLICAZIONI VARIE / VARIOUS APPLICATIONS	KB VB C	W: 36mm L: 2300mm

DENT: Dentata - Cogged | **DENT-2:** Dentata accoppiata - Cogged 2 ribs | **DENT-3:** Dentata tripla - Cogged 3 ribs | **MULT:** Multipla - Kraftbands
LISCIA: Non dentata - Not cogged | **A:** Alternatore - Alternator | **C:** Condizionatore - Air conditioner | **CPR:** Compressore - Compressor | **D:** Distribu-
 zione - Timing system | **P:** Pompa acqua - Water pump | **V:** Ventilatore - Fan | **PS:** Idroguida - Power steering | **HP:** Pompa idraulica - Hydraulic pump

References	Car maker	Type	Dimensions
LEM4EPK1041L 504129824 504146539	IVECO EUROTECH/STAR/TRAKKER CURSOR-STRALIS (CURSOR 10/F3A-13/F3B) CINGHIA ELASTICA - ELASTIC BELT	POLI-V C	4 gole - ribs L: 1041mm
LEM4EPK1102L 504087247 5801419157	IVECO BUS DAILY 35S14-35S14/15/18 M.Y.2006-40C17-40/50C15/18 M.Y.2006 CINGHIA ELASTICA - ELASTIC BELT	POLI-V C	4 gole - ribs L: 1102mm
LEM4EPK903L 5802102136 504066407	IVECO BUS DAILY 35S12-35S14 M.Y.2006 (MOT. F1A) CINGHIA ELASTICA - ELASTIC BELT	POLI-V C	4 gole - ribs L: 903mm
LEM4EPK903L 5802102136 504066407	IVECO DUCATO 2.3 DAILY 29L10/12/14-35C10/12/14-35S10/12/14 CINGHIA ELASTICA - ELASTIC BELT	POLI-V C	4 gole - ribs L: 903mm
LEM4EPK996L 504129827	IVECO EUROTECH CURSOR-EUROTRAKKER CURSOR-STRALIS CINGHIA ELASTICA - ELASTIC BELT	POLI-V C	4 gole - ribs L: 996mm
LEM4PK1013L 500329310	IVECO DAILY 35C9/C11/C13-35S9/S11/S13-50/65C11/C13	POLI-V C	4 gole - ribs L: 1013mm
LEM4PK1013L 5010284916	RENAULT MASCOTT	POLI-V C	4 gole - ribs L: 1013mm
LEM4PK1026L 504032641	IVECO BUS 399.35 MYWAY-ARWAY E4-CITELIS-CITYCLASS 491.27 CNG-591.27 CNG CITYCLASS .25/29/35-EUROCLASS .35-EURORIDER .31/33/35 EUROPOLIS CNG	POLI-V P	4 gole - ribs L: 1026mm
LEM4PK1026L 99472776	IVECO EUROTECH CURSOR E24/E27/31/3-EUROTRAKKER CURSOR	POLI-V C	4 gole - ribs L: 1026mm
LEM4PK1050L 500341618	IVECO DAILY III (8140.43 B/C/K/N/R/S)	POLI-V A	4 gole - ribs L: 1050mm
LEM4PK1070L 504020489	IVECO EUROTECH/STAR CURSOR E39/E43-EUROTRAKKER CURSOR E38/E44	POLI-V C	4 gole - ribs L: 1070mm
LEM4PK985L 504012393	FIAT DUCATO 2300 JTD	POLI-V A	4 gole - ribs L: 985mm
LEM4PK985L 504012393	IVECO DAILY 29L10/12-35C10/12-35S10/12-50C12 (? MOT. 113339)	POLI-V C	4 gole - ribs L: 985mm
LEM5PK1025L 5010295397 5010477334	RENAULT R310/330/340/365-G MANAGER-PREMIUM (?1999) PREMIUM-KERAX (2000?)	POLI-V A	5 gole - ribs L: 1025mm
LEM5PK1208L 7700300347	RENAULT MASTER (11/1997?09/2003 - MOT. S8U 770/772-S9W 700/702)	POLI-V A	5 gole - ribs L: 1208mm

DENT: Dentata - *Cogged* | **DENT-2:** Dentata accoppiata - *Cogged 2 ribs* | **DENT-3:** Dentata tripla - *Cogged 3 ribs* | **MULT:** Multipla - *Kraftbands*
LISCIA: Non dentata - *Not cogged* | **A:** Alternatore - *Alternator* | **C:** Condizionatore - *Air conditioner* | **CPR:** Compressore - *Compressor* | **D:** Distribu-
zione - *Timing system* | **P:** Pompa acqua - *Water pump* | **V:** Ventilatore - *Fan* | **PS:** Idroguida - *Power steering* | **HP:** Pompa idraulica - *Hydraulic pump*

References	Car maker	Type	Dimensions
LEM5PK1540L 5000678605	RENAULT AE385/420TI-R385/420TI	POLI-V A P	5 gole - ribs L: 1540mm
LEM6PK1050L 500368902	IVECO BUS DAILY BUS C9/11/13/15	POLI-V P	6 gole - ribs L: 1050mm
LEM6PK1050L 500368902	IVECO DAILY C9/11/13/15	POLI-V P	6 gole - ribs L: 1050mm
LEM6PK1050L 5010437648	RENAULT MASCOTT	POLI-V P	6 gole - ribs L: 1050mm
LEM6PK1067L 5010359915	RENAULT GR/TR280/305-GRH/TRH305-MIDLINER-PREMIUM-KERAX	POLI-V A	6 gole - ribs L: 1067mm
LEM6PK1110L 5010095041	RENAULT AE500 (10/1993 ?)-AE520	POLI-V C	6 gole - ribs L: 1110mm
LEM6PK1115L	UNIVERSAL APPLICAZIONI VARIE / VARIOUS APPLICATIONS	POLI-V	6 gole - ribs L: 1115mm
LEM6PK1216L 504092335	IVECO BUS DAILY BUS 35S14/15/18-40/50C15/17/18	POLI-V A	6 gole - ribs L: 1216mm
LEM6PK1216L 504092335	IVECO DAILY 35C14/15/17/18-35S17-40C14-65C14/15/17/18	POLI-V A	6 gole - ribs L: 1216mm
LEM6PK1245L 5000678543	RENAULT AE380/385TI/420TI	POLI-V	6 gole - ribs L: 1245mm
LEM6PK1411L 0019933796	MERCEDES SPRINTER	POLI-V A CPR P	6 gole - ribs L: 1411mm
LEM6PK1420L 5010330872 5010359916	RENAULT PREMIUM	POLI-V A	6 gole - ribs L: 1420mm
LEM6PK1570L 504032642	IVECO BUS CITYCLASS .25/29 (CURSOR)-CITYCLASS 491/591.27CNG EUROCLASS.35-EURORIDER .31/33 E4/35-EUROPOLIS CNG-ARWAY-CITELIS	POLI-V A	6 gole - ribs L: 1570mm
LEM6PK1610L 504032643	IVECO BUS CITYCLASS.35 (CURSOR)-EUROCLASS.35-EURORIDER .31/33 E4/35 399.35 MYWAY-ARWAY E4-CITELIS	POLI-V A	6 gole - ribs L: 1610mm
LEM6PK1658L 5000693021	RENAULT AE385TI/420TI	POLI-V A P	6 gole - ribs L: 1658mm
LEM6PK1697L 504050896	IVECO BUS EUROCLASS .36/43 (MOT. DCI 11)-EURORIDER.43 (MOT. DCI 11)	POLI-V A	6 gole - ribs L: 1697mm

DENT: Dentata - Cogged | **DENT-2:** Dentata accoppiata - Cogged 2 ribs | **DENT-3:** Dentata tripla - Cogged 3 ribs | **MULT:** Multipla - Kraftbands
LISCIA: Non dentata - Not cogged | **A:** Alternatore - Alternator | **C:** Condizionatore - Air conditioner | **CPR:** Compressore - Compressor | **D:** Distribu-
 zione - Timing system | **P:** Pompa acqua - Water pump | **V:** Ventilatore - Fan | **PS:** Idroguida - Power steering | **HP:** Pompa idraulica - Hydraulic pump

References	Car maker	Type	Dimensions
LEM6PK1755L 5000693140	RENAULT AE385TI/420TI-AE MAGNUM 420TI-R	POLI-V P	6 gole - ribs L: 1755mm
LEM6PK1758L 5801520716 504362408	IVECO NOVA DAILY 3.0 70C16 (FIC E3) DAILY (FIC E4-E5)	POLI-V A	6 gole - ribs L: 1758mm
LEM6PK1975L 5801683911	IVECO BUS CITELIS 18M (MOT. F2BE3682)	POLI-V A P	6 gole - ribs L: 1975mm
LEM6PK2260L 0019938696	MERCEDES SPRINTER-VITO-VIANO	POLI-V A C P PS	6 gole - ribs L: 2260mm
LEM6PK841L 7700300614	RENAULT MASTER (11/1997?09/2003 - MOT. S9W 700/702 ?03/2000)	POLI-V A	6 gole - ribs L: 841mm
LEM7PK1225L 5000681375	RENAULT BUS KAROSA (MIHR06.20.45)	POLI-V A	7 gole - ribs L: 1225mm
LEM7PK1322L 5802102050	IVECO BUS DAILY 35S12-35S14 M.Y.2006 (MOT. F1A)	POLI-V A	7 gole - ribs L: 1322mm
LEM7PK1322L 5802102050	IVECO DAILY 29L10/12/14-35C10/12/14-35S10/12/14-40C12-50C12	POLI-V A V	7 gole - ribs L: 1322mm
LEM7PK1338L 504384313	IVECO DAILY 29L11/13/15-33S/35C/35S11/13/15 (F1AE3481-F1AFL411)	POLI-V A	7 gole - ribs L: 1338mm
LEM7PK1752L 01812162	DAF CF85 IV-XF95-XF105	POLI-V P V	7 gole - ribs L: 1752mm
LEM8PK1035L 977828	VOLVO FH12 (1*T)-FL12-NH12-BUS B12 FM7 CON CONDIZIONATORE / WITH AIR CONDITIONING	POLI-V A V	8 gole - ribs L: 1035mm
LEM8PK1055L 977832	VOLVO FH12-BUS B12 FH16	POLI-V A V	8 gole - ribs L: 1055mm
LEM8PK1165L 5802377693	IVECO STRALIS 190S31-260S30/31/33 (E4-E6)	POLI-V	8 gole - ribs L: 1165mm
LEM8PK1165L D055787	MENARINI BUS STRALIS 190S31-260S30/31/33 (E4-E6)	POLI-V	8 gole - ribs L: 1165mm
LEM8PK1215L 5006003648 5006027785	IVECO BUS AXER	POLI-V C V	8 gole - ribs L: 1215mm
LEM8PK1215L 5419972892	MERCEDES ACTROS CON CONDIZIONATORE / WITH AIR CONDITIONING (IN COPPIA CON / FIT TOGETHER WITH 11PK2835)	POLI-V A C P V	8 gole - ribs L: 1215mm

DENT: Dentata - Cogged | **DENT-2:** Dentata accoppiata - Cogged 2 ribs | **DENT-3:** Dentata tripla - Cogged 3 ribs | **MULT:** Multipla - Kraftbands
LISCIA: Non dentata - Not cogged | **A:** Alternatore - Alternator | **C:** Condizionatore - Air conditioner | **CPR:** Compressore - Compressor | **D:** Distribu-
 zione - Timing system | **P:** Pompa acqua - Water pump | **V:** Ventilatore - Fan | **PS:** Idroguida - Power steering | **HP:** Pompa idraulica - Hydraulic pump

References	Car maker	Type	Dimensions
LEM8PK1226L 1702604	DAF LF45-LF55-CF65	POLI-V A	8 gole - ribs L: 1226mm
LEM8PK1230L 5802350474 4898546	IVECO TECTOR (6 CYL) - EUROFIRE TECTOR (6 CYL)	POLI-V A P V	8 gole - ribs L: 1230mm
LEM8PK1230L 9069973092	MERCEDES ATEGO	POLI-V A P V	8 gole - ribs L: 1230mm
LEM8PK1230L 20564266 979956	VOLVO FL10 (EURO2)	POLI-V A	8 gole - ribs L: 1230mm
LEM8PK1255L 1800523	SCANIA 164 - P-,G-,R-,T- SERIES	POLI-V V	8 gole - ribs L: 1255mm
LEM8PK1275L 5801365662	IVECO TECTOR E6	POLI-V A	8 gole - ribs L: 1275mm
LEM8PK1275L 51968200243	MAN D0834-D0836-D2066-TGM	POLI-V A	8 gole - ribs L: 1275mm
LEM8PK1275L 21190818 20412534	VOLVO FM9 (SENZA ARIA CONDIZIONATA / WITHOUT AIR CONDITIONING)	POLI-V A	8 gole - ribs L: 1275mm
LEM8PK1365L 9069933996	MERCEDES ATEGO-AXOR-CITARO-VARIO	POLI-V A	8 gole - ribs L: 1365mm
LEM8PK1365L 21190817 20412535	VOLVO FM9 (CON ARIA CONDIZIONATA / WITH AIR CONDITIONING)	POLI-V A	8 gole - ribs L: 1365mm
LEM8PK1376L 51968200239	MAN TGA	POLI-V C	8 gole - ribs L: 1376mm
LEM8PK1376L 9069937996	MERCEDES ATEGO-ATEGO 2	POLI-V P	8 gole - ribs L: 1376mm
LEM8PK1376L 20580937	VOLVO FH12-FH16-FM12-FM13	POLI-V A	8 gole - ribs L: 1376mm
LEM8PK1381L 5802350473 504013617	IVECO APPLICAZIONI VARIE / VARIOUS APPLICATIONS	POLI-V A P	8 gole - ribs L: 1381mm
LEM8PK1400L 0067690	DAF 45-F600-F1000	POLI-V V	8 gole - ribs L: 1400mm

DENT: Dentata - Cogged | **DENT-2:** Dentata accoppiata - Cogged 2 ribs | **DENT-3:** Dentata tripla - Cogged 3 ribs | **MULT:** Multipla - Kraftbands
LISCIA: Non dentata - Not cogged | **A:** Alternatore - Alternator | **C:** Condizionatore - Air conditioner | **CPR:** Compressore - Compressor | **D:** Distribu-
zione - Timing system | **P:** Pompa acqua - Water pump | **V:** Ventilatore - Fan | **PS:** Idroguida - Power steering | **HP:** Pompa idraulica - Hydraulic pump

References	Car maker	Type	Dimensions
LEM8PK1400L 20464710	VOLVO FM9 - B9	POLI-V A	8 gole - ribs L: 1400mm
LEM8PK1420L 9069972492	MERCEDES AXOR-ATEGO-ATEGO II-ACCELO	POLI-V V	8 gole - ribs L: 1420mm
LEM8PK1427L 009069937196	MERCEDES AXOR-ATEGO	POLI-V P	8 gole - ribs L: 1427mm
LEM8PK1436L 7422100457 7421190804	RENAULT PREMIUM-KERAX	POLI-V A	8 gole - ribs L: 1436mm
LEM8PK1436L 20430378	VOLVO FM10	POLI-V A	8 gole - ribs L: 1436mm
LEM8PK1450L 7421371750	RENAULT C-K-T SERIES (D11)	POLI-V A	8 gole - ribs L: 1450mm
LEM8PK1480L 51968200352	MAN D2868	POLI-V A	8 gole - ribs L: 1480mm
LEM8PK1480L 9069970792	MERCEDES AXOR-AXOR II-ATEGO-ATEGO II	POLI-V P V	8 gole - ribs L: 1480mm
LEM8PK1495L 06580490038	MAN BUS LION'S CITY-LION'S CLASSIC-NÜ 313	POLI-V A	8 gole - ribs L: 1495mm
LEM8PK1510L 7420725537	RENAULT KERAX DXI 13-MAGNUM DXI 13	POLI-V A C	8 gole - ribs L: 1510mm
LEM8PK1515L 7420725537	RENAULT MAGNUM DXI13 - KERAX DXI13	POLI-V A C	8 gole - ribs L: 1515mm
LEM8PK1520L 1702605 1388161	DAF 65CF-CF65-LF45-LF55	POLI-V A C P V	8 gole - ribs L: 1520mm
LEM8PK1520L 7420543481	RENAULT PREMIUM-KERAX	POLI-V A	8 gole - ribs L: 1520mm
LEM8PK1520L 1800535	SCANIA 124-K114-K124 (NO ARIA CONDIZIONATA/WITHOUT AIR CONDITIONING)	POLI-V A	8 gole - ribs L: 1520mm
LEM8PK1526L 7421190803	RENAULT PREMIUM-KERAX-KERAX DXI11	POLI-V A	8 gole - ribs L: 1526mm
LEM8PK1537L 9069975092	MERCEDES OM904-OM906-OM924-OM926	POLI-V A	8 gole - ribs L: 1537mm

DENT: Dentata - Cogged | **DENT-2:** Dentata accoppiata - Cogged 2 ribs | **DENT-3:** Dentata tripla - Cogged 3 ribs | **MULT:** Multipla - Kraftbands
LISCIA: Non dentata - Not cogged | **A:** Alternatore - Alternator | **C:** Condizionatore - Air conditioner | **CPR:** Compressore - Compressor | **D:** Distribu-
 zione - Timing system | **P:** Pompa acqua - Water pump | **V:** Ventilatore - Fan | **PS:** Idroguida - Power steering | **HP:** Pompa idraulica - Hydraulic pump

References	Car maker	Type	Dimensions
LEM8PK1537L 22275091	VOLVO FH (II)-FM (II) (D13)	POLI-V A	8 gole - ribs L: 1537mm
LEM8PK1545L 1800522 1454281	SCANIA 114-124 SENZA CONDIZIONATORE (1 RULLO) / WITHOUT AIR COND. (1 SEAM)	POLI-V A P	8 gole - ribs L: 1545mm
LEM8PK1545L 22275091 20430611	VOLVO FH12-FH13-FM12-FM13-NH12	POLI-V A P	8 gole - ribs L: 1545mm
LEM8PK1548L 51968200326	MAN D0834 LOH40/50/51/52/53/60/61-D0836 LOH10/40/41/50	POLI-V A	8 gole - ribs L: 1548mm
LEM8PK1557L 7422670505	RENAULT C-SERIES - T-SERIES - K-SERIES (MOT. D13K)	POLI-V A	8 gole - ribs L: 1557mm
LEM8PK1557L 21371745	VOLVO FH-FH (II)-FM-FMX-FMX (II)	POLI-V A	8 gole - ribs L: 1557mm
LEM8PK1570L 982570	VOLVO FL6-FM (D11)-B9S	POLI-V A	8 gole - ribs L: 1570mm
LEM8PK1614L 0159973292 0019932596	MERCEDES AXOR	POLI-V P V	8 gole - ribs L: 1614mm
LEM8PK1614L 7700068536	RENAULT AXOR	POLI-V	8 gole - ribs L: 1614mm
LEM8PK1620L D055923	MENARINI BUS MENARINI (VERS. CON SPECIFICHE DI PRIMO IMPIANTO/1ST EQUIPMENT SPEC.)	POLI-V A P V	8 gole - ribs L: 1620mm
LEM8PK1630L 5802350478 500387660	IVECO BUS 200E.8.17-203E.9.26-203E.10.26-203E.8.21 EUROPO- LIS-203E.9.24-203E.9.26-ARWAY-EURORIDER.27-MIDIRIDER.27-MIDIRI- DER.30 E4	POLI-V A P V	8 gole - ribs L: 1630mm
LEM8PK1630L 5802350478 500387660	IVECO TECTOR E18/E21/E24	POLI-V A P V	8 gole - ribs L: 1630mm
LEM8PK1635L 51968200344	MAN TGA (NO ARIA CONDIZIONATA/WITHOUT AIR CONDITIONING)	POLI-V A	8 gole - ribs L: 1635mm
LEM8PK1635L 9069936796	MERCEDES OM906-OM926	POLI-V C P	8 gole - ribs L: 1635mm
LEM8PK1660L 504079075	IVECO BUS BUS	POLI-V A	8 gole - ribs L: 1660mm

DENT: Dentata - Cogged | **DENT-2:** Dentata accoppiata - Cogged 2 ribs | **DENT-3:** Dentata tripla - Cogged 3 ribs | **MULT:** Multipla - Kraftbands
LISCIA: Non dentata - Not cogged | **A:** Alternatore - Alternator | **C:** Condizionatore - Air conditioner | **CPR:** Compressore - Compressor | **D:** Distribu-
ziona - Timing system | **P:** Pompa acqua - Water pump | **V:** Ventilatore - Fan | **PS:** Idroguida - Power steering | **HP:** Pompa idraulica - Hydraulic pump

References	Car maker	Type	Dimensions
LEM8PK1660L 51968200346	MAN D2066-D2676	POLI-V A	8 gole - ribs L: 1660mm
LEM8PK1688L 5802350483 4898547	IVECO TECTOR (6 CYL) - EUROFIRE TECTOR (6 CYL)	POLI-V A C P V	8 gole - ribs L: 1688mm
LEM8PK1688L 11920LA30A	NISSAN ATLEON TK3 (MOT. CUMMINS ISB4/ISB6) CON ARIA CONDIZ./WITH AIR COND.	POLI-V C	8 gole - ribs L: 1688mm
LEM8PK1691L 5801616098	IVECO TECTOR (6 CYL) 2015/2019/E6	POLI-V A	8 gole - ribs L: 1691mm
LEM8PK1707L 5801381931	IVECO BUS BUS URBANWAY E6 - HEULIEZ GX	POLI-V A	8 gole - ribs L: 1707mm
LEM8PK1720L 1393365	DAF CF85-CF85 IV-XF95-YTZ95	POLI-V A V	8 gole - ribs L: 1720mm
LEM8PK1720L 20430380	VOLVO FM10-BUS B7L	POLI-V A C	8 gole - ribs L: 1720mm
LEM8PK1754L 5801574531	IVECO BUS CROSSWAY E6-URBANWAY E6-HEULIEZ GX127 E4	POLI-V A P V	8 gole - ribs L: 1754mm
LEM8PK1805L 5801521917	IVECO BUS CROSS.LE-CROSSWAY CNG-CROSSWAY LE-EVADYSRECREO-ARWAY (E6)	POLI-V A P V	8 gole - ribs L: 1805mm
LEM8PK1805L D356781	MENARINI BUS CROSS.LE-CROSSWAY CNG-CROSSWAY LE-EVADYSRECREO-ARWAY (E6)	POLI-V A P V	8 gole - ribs L: 1805mm
LEM8PK1805L 21457868	VOLVO BUS 8500-8700-9700-9900-B12	POLI-V A	8 gole - ribs L: 1805mm
LEM8PK1875L 51968200324	MAN BUS LION'S COACH L/C	POLI-V A	8 gole - ribs L: 1875mm
LEM8PK1875L D092064	MENARINI BUS BUS LION'S COACH L/C	POLI-V A P V	8 gole - ribs L: 1875mm
LEM8PK1895L 1763403	SCANIA P-,G-,R-,T- SERIES D9-D11-D12	POLI-V A C P V	8 gole - ribs L: 1895mm
LEM8PK1895L 20702710	VOLVO BUS B12B	POLI-V A C P V	8 gole - ribs L: 1895mm
LEM8PK1910L 1522450	DAF APPLICAZIONI VARIE / VARIOUS APPLICATIONS	POLI-V A	8 gole - ribs L: 1910mm

DENT: Dentata - *Cogged* | **DENT-2:** Dentata accoppiata - *Cogged 2 ribs* | **DENT-3:** Dentata tripla - *Cogged 3 ribs* | **MULT:** Multipla - *Kraftbands*
LISCIA: Non dentata - *Not cogged* | **A:** Alternatore - *Alternator* | **C:** Condizionatore - *Air conditioner* | **CPR:** Compressore - *Compressor* | **D:** Distribu-
zione - *Timing system* | **P:** Pompa acqua - *Water pump* | **V:** Ventilatore - *Fan* | **PS:** Idroguida - *Power steering* | **HP:** Pompa idraulica - *Hydraulic pump*

References	Car maker	Type	Dimensions
LEM8PK1910L N1011001840	MAN APPLICAZIONI VARIE / VARIOUS APPLICATIONS	POLI-V A	8 gole - ribs L: 1910mm
LEM8PK1910L D062429	MENARINI BUS APPLICAZIONI VARIE / VARIOUS APPLICATIONS	POLI-V A P	8 gole - ribs L: 1910mm
LEM8PK1910L 9069972892	MERCEDES ATEGO (MOT. OM904/906 LA)	POLI-V A P	8 gole - ribs L: 1910mm
LEM8PK1914L 5006178484	IVECO BUS BUS	POLI-V C	8 gole - ribs L: 1914mm
LEM8PK1914L 51968200345	MAN TGA	POLI-V C	8 gole - ribs L: 1914mm
LEM8PK1914L 9069934196	MERCEDES ATEGO-CITARO (MOT. OM904/906 LA)	POLI-V A P	8 gole - ribs L: 1914mm
LEM8PK1939L 9069933396	MERCEDES ATEGO-AXOR	POLI-V A	8 gole - ribs L: 1939mm
LEM8PK1939L 7700066725	RENAULT MASTER	POLI-V A	8 gole - ribs L: 1939mm
LEM8PK1985L 9069973292	MERCEDES ATEGO-CITARO-ECONIC	POLI-V A P V	8 gole - ribs L: 1985mm
LEM8PK2000L 9069971292	MERCEDES ATEGO-AXOR-AXOR 2	POLI-V P	8 gole - ribs L: 2000mm
LEM8PK2020L 1920232	SCANIA P-,R-,T- SERIES DC9-DC11-DC12	POLI-V A P	8 gole - ribs L: 2020mm
LEM8PK2020L 1920232	SCANIA P-,R-,T- SERIES DC9-DC11-DC12	POLI-V A P	8 gole - ribs L: 2020mm
LEM8PK2045L 1393280	DAF CF85	POLI-V A P	8 gole - ribs L: 2045mm
LEM8PK2045L 9069972392	MERCEDES ATEGO 1217-1317-1322-1329-1523-1828 - CITARO-ECONIC	POLI-V A P	8 gole - ribs L: 2045mm
LEM8PK2045L 1800537	SCANIA 94-144 CON CONDIZIONATORE (2 RULLI) / WITH AIR COND. (2 SEAMS)	POLI-V A P	8 gole - ribs L: 2045mm
LEM8PK2055L 20459724	VOLVO BUS B12M	POLI-V A	8 gole - ribs L: 2055mm
LEM8PK2085L 9069971192	MERCEDES ATEGO-AXOR-ECONIC	POLI-V A P C	8 gole - ribs L: 2085mm

DENT: Dentata - Cogged | **DENT-2:** Dentata accoppiata - Cogged 2 ribs | **DENT-3:** Dentata tripla - Cogged 3 ribs | **MULT:** Multipla - Kraftbands
LISCIA: Non dentata - Not cogged | **A:** Alternatore - Alternator | **C:** Condizionatore - Air conditioner | **CPR:** Compressore - Compressor | **D:** Distribu-
 zione - Timing system | **P:** Pompa acqua - Water pump | **V:** Ventilatore - Fan | **PS:** Idroguida - Power steering | **HP:** Pompa idraulica - Hydraulic pump

References	Car maker	Type	Dimensions
LEM8PK2085L 1888471	SCANIA 164 CON CONDIZIONATORE / WITH AIR CONDITIONING	POLI-V A P C	8 gole - ribs L: 2085mm
LEM8PK2085L 20727029	VOLVO ATEGO-AXOR-ECONIC	POLI-V A	8 gole - ribs L: 2085mm
LEM8PK2100L D055924	MENARINI BUS APPLICAZIONI VARIE / VARIOUS APPLICATIONS	POLI-V	8 gole - ribs L: 2100mm
LEM8PK2100L 9049970192	MERCEDES ATEGO (MOT. OM904 LA)	POLI-V P V	8 gole - ribs L: 2100mm
LEM8PK2135L 1888468	SCANIA 124 CON CONDIZIONATORE / WITH AIR CONDITIONING BUS K94-L94-N94-K114-K124	POLI-V A P	8 gole - ribs L: 2135mm
LEM8PK2163L 1800538	SCANIA 144 CON CONDIZIONATORE (1 RULLO) / WITH AIR CONDITIONING (1 SEAM)	POLI-V A P C	8 gole - ribs L: 2163mm
LEM8PK2317L 1878371	DAF CF-XF CON CONDIZIONATORE / WITH AIR CONDITIONING	POLI-V P	8 gole - ribs L: 2317mm
LEM8PK2317L 9369930396	MERCEDES ACTROS 4/5-ANTOS-AROCS-ATEGO 3-ECONIC 2	POLI-V P V	8 gole - ribs L: 2317mm
LEM8PK2380L 1398637	DAF 75CF-CF75	POLI-V A P	8 gole - ribs L: 2380mm
LEM8PK2380L 0109972992	MERCEDES BUS O 404	POLI-V C	8 gole - ribs L: 2380mm
LEM8PK2380L 1800527	SCANIA BUS K94-L94-N94	POLI-V A P	8 gole - ribs L: 2380mm
LEM8PK2395L 1800526	SCANIA BUS K94-L94-N94 (2°T)	POLI-V A P	8 gole - ribs L: 2395mm
LEM8PK2400L 1490820	SCANIA APPLICAZIONI VARIE / VARIOUS APPLICATIONS	POLI-V	8 gole - ribs L: 2400mm
LEM8PK2415L 1939934	DAF CF-XF (MOT. MX11)	POLI-V P	8 gole - ribs L: 2415mm
LEM8PK2631L 4719935896	MERCEDES ACTROS-ANTOS-AROCS	POLI-V P	8 gole - ribs L: 2631mm
LEM8PK800L 978207	VOLVO FH12 (2°T)-FM12-NH12 SENZA CONDIZIONATORE / WITHOUT AIR CONDITIONING	POLI-V A	8 gole - ribs L: 800mm

DENT: Dentata - Cogged | **DENT-2:** Dentata accoppiata - Cogged 2 ribs | **DENT-3:** Dentata tripla - Cogged 3 ribs | **MULT:** Multipla - Kraftbands
LISCIA: Non dentata - Not cogged | **A:** Alternatore - Alternator | **C:** Condizionatore - Air conditioner | **CPR:** Compressore - Compressor | **D:** Distribu-
 zione - Timing system | **P:** Pompa acqua - Water pump | **V:** Ventilatore - Fan | **PS:** Idroguida - Power steering | **HP:** Pompa idraulica - Hydraulic pump

References	Car maker	Type	Dimensions
LEM8PK880L 51968200238	MAN F2000-TGA	POLI-V C	8 gole - ribs L: 880mm
LEM8PK900L 1676688 978227	VOLVO FH12-FL12-NH12	POLI-V A	8 gole - ribs L: 900mm
LEM8PK955L 978238	VOLVO FH12 (2°T)-FL12-NH12 CON CONDIZIONATORE / WITH AIR CONDITIONING	POLI-V A	8 gole - ribs L: 955mm
LEM8PK975L 7420715585	RENAULT MAGNUM DXI 12	POLI-V A	8 gole - ribs L: 975mm
LEM8PK975L 20430367 20430368	VOLVO FH16 FM7-FH12-FM12-NH12	POLI-V A V	8 gole - ribs L: 975mm
LEM9PK1200L 51968200265	MAN D 0826 - EM/HOCL/NM	POLI-V	9 gole - ribs L: 1200mm
LEM9PK1200L 5000686684	RENAULT R385TI/420TI	POLI-V V	9 gole - ribs L: 1200mm
LEM9PK1295L 5000686750	RENAULT AE385TI/420TI-CBH/CLM320/385-AE MAGNUM 420TI	POLI-V V	9 gole - ribs L: 1295mm
LEM9PK1380L 1661948	DAF CF85 IV-XF95-XF105	POLI-V A V	9 gole - ribs L: 1380mm
LEM9PK1424L 1661949	DAF CF85-XF105 (MOT. MX)	POLI-V P	9 gole - ribs L: 1424mm
LEM9PK1449L 1673514	DAF CF85 IV-XF105	POLI-V A P V	9 gole - ribs L: 1449mm
LEM9PK1690L 5010477838	RENAULT PREMIUM-KERAX	POLI-V V	9 gole - ribs L: 1690mm
LEM9PK1699L 0009932596	MERCEDES AXOR	POLI-V V	9 gole - ribs L: 1699mm
LEM9PK1881L 0149977392	MERCEDES ACTROS 1840-1848-2635-2648-2653 - AXOR-TRAVEGO	POLI-V A C P V	9 gole - ribs L: 1881mm
LEM9PK1881L 5419970892	MERCEDES ACTROS 1840-1848-2635-2648-2653 - AXOR-TRAVEGO	POLI-V A C P V	9 gole - ribs L: 1881mm
LEM9PK1920L 0139975792	MERCEDES ACTROS-ACTROS 2	POLI-V A	9 gole - ribs L: 1920mm

DENT: Dentata - Cogged | **DENT-2:** Dentata accoppiata - Cogged 2 ribs | **DENT-3:** Dentata tripla - Cogged 3 ribs | **MULT:** Multipla - Kraftbands
LISCIA: Non dentata - Not cogged | **A:** Alternatore - Alternator | **C:** Condizionatore - Air conditioner | **CPR:** Compressore - Compressor | **D:** Distribu-
 zione - Timing system | **P:** Pompa acqua - Water pump | **V:** Ventilatore - Fan | **PS:** Idroguida - Power steering | **HP:** Pompa idraulica - Hydraulic pump

References	Car maker	Type	Dimensions
LEM9PK2000L 0139973592	MERCEDES AXOR BUS TOURISMO-TRAVEGO	POLI-V A V	9 gole - ribs L: 2000mm
LEM9PK2010L 0139971792	MERCEDES BUS SETRA S 415 GT	POLI-V C	9 gole - ribs L: 2010mm
LEM9PK2125L 0019935696	MERCEDES BUS CITARO	POLI-V A P	9 gole - ribs L: 2125mm
LEM9PK2140L 0019932796 0049930196	MERCEDES AXOR 2	POLI-V V	9 gole - ribs L: 2140mm
LEM9PK2338L 0019932496	MERCEDES AXOR 2	POLI-V V	9 gole - ribs L: 2338mm
LEM9PK2835L 5419970992	MERCEDES ACTROS CON CONDIZIONATORE / WITH AIR CONDITIONING	POLI-V P V	9 gole - ribs L: 2835mm
LEM9PK2871L 0019937296	MERCEDES ACTROS	POLI-V A	9 gole - ribs L: 2871mm
LEM9PK4145L 0109970992	MERCEDES BUS O 404 (MOT. OM441) - OH SERIES - TOURISMO (O 350)	POLI-V V	9 gole - ribs L: 4145mm
LEM9PK4145L 4768010000	SETRA BUS	POLI-V V	9 gole - ribs L: 4145mm
LEM9PK4168L 0109971292	MERCEDES MERCEDES	POLI-V V	9 gole - ribs L: 4168mm
LEM10PK1070L 20430381	VOLVO FM10-FM12-FM	POLI-V V	10 gole - ribs L: 1070mm
LEM10PK1110L 7420715587	RENAULT MAGNUM DXI12	POLI-V V	10 gole - ribs L: 1110mm
LEM10PK1110L 20430382	VOLVO FH12-FM12-NH12 (DC12 380-460 HP)	POLI-V V	10 gole - ribs L: 1110mm
LEM10PK1150L 20430384	VOLVO FH12-NH12 (DC12 340-420 HP)	POLI-V V	10 gole - ribs L: 1150mm
LEM10PK1215L 5000681376	RENAULT BUS TRACER	POLI-V	10 gole - ribs L: 1215mm
LEM10PK1300L 51968200241	MAN BUS LION'S CITY A37	POLI-V	10 gole - ribs L: 1300mm

DENT: Dentata - Cogged | **DENT-2:** Dentata accoppiata - Cogged 2 ribs | **DENT-3:** Dentata tripla - Cogged 3 ribs | **MULT:** Multipla - Kraftbands
LISCIA: Non dentata - Not cogged | **A:** Alternatore - Alternator | **C:** Condizionatore - Air conditioner | **CPR:** Compressore - Compressor | **D:** Distribu-
 zione - Timing system | **P:** Pompa acqua - Water pump | **V:** Ventilatore - Fan | **PS:** Idroguida - Power steering | **HP:** Pompa idraulica - Hydraulic pump

References	Car maker	Type	Dimensions
LEM10PK1342L 7421190824 7422100459	RENAULT PREMIUM DXI7/DXI11-KERAX DCI11/DXI11	POLI-V A	10 gole - ribs L: 1342mm
LEM10PK1342L 21955032	VOLVO FM (VE11)	POLI-V V	10 gole - ribs L: 1342mm
LEM10PK1370L 9069972692	MERCEDES CITARO	POLI-V A	10 gole - ribs L: 1370mm
LEM10PK1370L 20411420 21190827	VOLVO FM9-FM (D9)	POLI-V V	10 gole - ribs L: 1370mm
LEM10PK1448L 61585791	IVECO BUS 580-670-671 I-EFFEUNO-671 U-EFFEUNO	POLI-V A	10 gole - ribs L: 1448mm
LEM10PK1448L 20712530	VOLVO FM (D13)	POLI-V V	10 gole - ribs L: 1448mm
LEM10PK1460L 5010437603	RENAULT AE MAGNUM-MAGNUM E-TECH	POLI-V A	10 gole - ribs L: 1460mm
LEM10PK1487L 7420724776	RENAULT MAGNUM DXI13	POLI-V V	10 gole - ribs L: 1487mm
LEM10PK1487L 11709635	VOLVO FH (II) (D13)	POLI-V V	10 gole - ribs L: 1487mm
LEM10PK1512L 20712534	VOLVO FH (D13) - B13 (D13)	POLI-V V	10 gole - ribs L: 1512mm
LEM10PK1540L 5001857588 5010409408 5000681374	RENAULT APPLICAZIONI VARIE / VARIOUS APPLICATIONS	POLI-V	10 gole - ribs L: 1540mm
LEM10PK1545L 500339996	IVECO STRALIS	POLI-V V	10 gole - ribs L: 1545mm
LEM10PK1545L 7421314462	RENAULT T SERIES (DTI13 - SENZA RALLENTATORE/WITHOUT RETARDER)	POLI-V V	10 gole - ribs L: 1545mm
LEM10PK1545L 24016649	VOLVO FH/FM/FMX (D13) - FH (D16K) - B13 (D13)	POLI-V V	10 gole - ribs L: 1545mm
LEM10PK1570L 5000686803 7421531749	RENAULT APPLICAZIONI VARIE / VARIOUS APPLICATIONS	POLI-V A	10 gole - ribs L: 1570mm

DENT: Dentata - Cogged | **DENT-2:** Dentata accoppiata - Cogged 2 ribs | **DENT-3:** Dentata tripla - Cogged 3 ribs | **MULT:** Multipla - Kraftbands
LISCIA: Non dentata - Not cogged | **A:** Alternatore - Alternator | **C:** Condizionatore - Air conditioner | **CPR:** Compressore - Compressor | **D:** Distribu-
 zione - Timing system | **P:** Pompa acqua - Water pump | **V:** Ventilatore - Fan | **PS:** Idroguida - Power steering | **HP:** Pompa idraulica - Hydraulic pump

References	Car maker	Type	Dimensions
LEM10PK1570L 1865153	SCANIA P-,G-,R-,T- SERIES DC16 XPI	POLI-V V	10 gole - ribs L: 1570mm
LEM10PK1570L 22707523	VOLVO FM7	POLI-V A	10 gole - ribs L: 1570mm
LEM10PK1705L 51968200381	MAN BUS LION'S CITY M	POLI-V	10 gole - ribs L: 1705mm
LEM10PK1705L 7420846321	RENAULT MIDLUM DX15-DX17	POLI-V	10 gole - ribs L: 1705mm
LEM10PK1705L 20846320	VOLVO FL	POLI-V C V	10 gole - ribs L: 1705mm
LEM10PK1714L 5801496097	IVECO EUROTRAKKER AD/AT CURSOR-STRALIS AD/AT (CURSOR 8/F2B)	POLI-V P V	10 gole - ribs L: 1714mm
LEM10PK1725L 500328020	IVECO EUROTECH CURSOR-EUROTRAKKER CURSOR-STRALIS (CURSOR 8/F2B)	POLI-V V	10 gole - ribs L: 1725mm
LEM10PK1768L 9069972192	MERCEDES BUS TOURINO (MOT. OM906 LA)	POLI-V	10 gole - ribs L: 1768mm
LEM10PK1783L 20860507	VOLVO BUS B7	POLI-V A	10 gole - ribs L: 1783mm
LEM10PK1814L 9069936696 9069974792	MERCEDES BUS CITARO O 530	POLI-V V	10 gole - ribs L: 1814mm
LEM10PK2020L 1935423 1779746 1779747	SCANIA P-,G-,R-,T- SERIES D13 - BUS F-,K-,N- SERIES (LATO INTERNO/INSIDE) (VEDI/SEE 10PK2220)	POLI-V A	10 gole - ribs L: 2020mm
LEM10PK2220L 20889843	VOLVO BUS B7R	POLI-V C	10 gole - ribs L: 2220mm
LEM10PK2253L 9069933896	MERCEDES ATEGO-ATEGO 2-AXOR 2-ECONIC-VARIO-CITARO-CONECTO	POLI-V A P	10 gole - ribs L: 2253mm
LEM10PK2258L 5801683893	IVECO BUS BUS CITELIS 12M/18M (CURSOR 8/F2BE3682)	POLI-V C	10 gole - ribs L: 2258mm
LEM10PK2296L 5801488667	IVECO BUS CROSSWAY E6 - URBANWAY E6 - HEULIEZ GX	POLI-V C	10 gole - ribs L: 2296mm
LEM10PK2335L 51968200387	MAN BUS LION'S COACH	POLI-V C	10 gole - ribs L: 2335mm

DENT: Dentata - *Cogged* | **DENT-2:** Dentata accoppiata - *Cogged 2 ribs* | **DENT-3:** Dentata tripla - *Cogged 3 ribs* | **MULT:** Multipla - *Kraftbands*
LISCIA: Non dentata - *Not cogged* | **A:** Alternatore - *Alternator* | **C:** Condizionatore - *Air conditioner* | **CPR:** Compressore - *Compressor* | **D:** Distribu-
 zione - *Timing system* | **P:** Pompa acqua - *Water pump* | **V:** Ventilatore - *Fan* | **PS:** Idroguida - *Power steering* | **HP:** Pompa idraulica - *Hydraulic pump*

References	Car maker	Type	Dimensions
LEM10PK2475L 1920231 1529222	SCANIA P-,G-,R-,T- SERIES D9-D13 - BUS F-,K-,N- SERIES	POLI-V A P C	10 gole - ribs L: 2475mm
LEM10PK2700L 1742710	SCANIA BUS F-,K- SERIES - CITYWIDE (DC9) - INTERLINK/OMNILINK (DC9/13-OC09)	POLI-V V	10 gole - ribs L: 2700mm
LEM11PK1480L	UNIVERSAL APPLICAZIONI VARIE / VARIOUS APPLICATIONS	POLI-V	11 gole - ribs L: 1480mm
LEM11PK2017L 0019936096	MERCEDES ATEGO-ACTROS-AXOR-ECONIC-CITARO-CONECTO-TOURISMO	POLI-V C	11 gole - ribs L: 2017mm
LEM11PK2044L 0019936196 0129976392	MERCEDES BUS CITARO	POLI-V V	11 gole - ribs L: 2044mm
LEM12PK1818L 500341808 504027703	IVECO EUROTECH CURSOR-EUROSTAR CURSOR-STRALIS (CURSOR 10/F3A)	POLI-V A P V	12 gole - ribs L: 1818mm
LEM12PK1830L 500341810 504022568	IVECO EUROSTAR CURSOR-EUROTRAKKER CURSOR-STRALIS (CURSOR 13/F3B)	POLI-V A P V	12 gole - ribs L: 1830mm
LEM12PK1835L 504049426	IVECO STRALIS (CURSOR 13/F3B)	POLI-V A	12 gole - ribs L: 1835mm
LEM12PK1932L 1928775	DAF CF-XF (MX11)	POLI-V HP	12 gole - ribs L: 1932mm
LEM12PK1932L 5801877307	IVECO STRALIS-X-WAY (CURSOR 13/F3G - CON RALLENTATORE/WITH RETARDER)	POLI-V A P V	12 gole - ribs L: 1932mm

DENT: Dentata - Cogged | **DENT-2:** Dentata accoppiata - Cogged 2 ribs | **DENT-3:** Dentata tripla - Cogged 3 ribs | **MULT:** Multipla - Kraftbands
LISCIA: Non dentata - Not cogged | **A:** Alternatore - Alternator | **C:** Condizionatore - Air conditioner | **CPR:** Compressore - Compressor | **D:** Distribu-
zione - Timing system | **P:** Pompa acqua - Water pump | **V:** Ventilatore - Fan | **PS:** Idroguida - Power steering | **HP:** Pompa idraulica - Hydraulic pump



Kit Distribuzione e Ausiliari Timing and accessory kits

*Per applicazione veicoli commerciali leggeri e pesanti
Suitable for LCV and HDV applications.*

Suitable for **FIAT**

Adatto a **FIAT**

HB200K

Kit cinghie dentate / Timing Belt Set

Suitable for: FIAT - F1AE0481G - DUCATO 2.3



DUBHE REF.	Q.TY	OE REF.	Descrizione / Description
HB238	1	5802473355	Rullo tenditore / Tensioner Pulley - F1AE0481/3481 DAILY/DUCATO
HB302	1	500388688	Galoppino/Guidacinghia / Deflection/Guide Pulley - F1AE0481/3481 DAILY/DUCATO
293055	1	500371975	Cinghia dentata / Timing Belt - DAILY/DUCATO F1A 2.3 HPI

HB205K

Pompa acqua + Kit cinghie dentate / Water Pump + Timing Belt Set

Suitable for: FIAT - F1AGL411/F1AE0481/3841 - DAILY/DUCATO 2.3 D



DUBHE REF.	Q.TY	OE REF.	Descrizione / Description
HB238	1	5802473355	Rullo tenditore / Tensioner Pulley - F1AE0481/3481 DAILY/DUCATO
HB302	1	500388688	Galoppino/Guidacinghia / Deflection/Guide Pulley - F1AE0481/3481 DAILY/DUCATO
293055	1	500371975	Cinghia dentata / Timing Belt - DAILY/DUCATO F1A 2.3 HPI
630327	1	16674634	Bullone/Vite / Screw - M8X60MM
LEM125275	1	17291281	Anello di tenuta / Seal Ring - 3,53X94,84 FPM
LEM105100	1	17289680	Anello di tenuta / Seal Ring - 3,53X44,45 NBR
350380	1	6000636669	Pompa acqua / Water pump - F1AE0481 - DAILY 35C10/S10 - DUCATO 2.3JTD Con OR + guarnizione / With OR + gasket

HB210K

Kit Cinghie Poly-V / V-Ribbed Belt Set

Suitable for: FIAT - DUCATO 2.3 D MJT 2006 ->



DUBHE REF.	Q.TY	OE REF.	Descrizione / Description
HB258	1	504000412	Galoppino/Guidacinghia / Deflection/Guide Pulley - F1A/F1C DUCATO/DAILY 2.3/3.0
HB314	1	504086751	Tendicinghia per Cinghia Poly-V / Belt Tensioner, V-ribbed belt - F1AE0481 DAILY 35C10/S10
LEM4EPK903L	1	5802102136	Cinghia Poly-V / V-Ribbed Belt - POLI-V HEAVYBELT elastica
LEM7PK1076L	1	500388408	Cinghia Poly-V / V-Ribbed Belt - POLI-V HEAVYBELT

Suitable for **IVECO**

Adatto a **IVECO**

HB400K

Kit Cinghie Poly-V / V-Ribbed Belt Set

Suitable for: IVECO - F1A DAILY 2.3



DUBHE REF.	Q.TY	OE REF.	Descrizione / Description
HB258	1	504000412	Galoppino/Guidacinghia / Deflection/Guide Pulley - F1A/F1C DUCATO/DAILY 2.3/3.0
HB314	1	2994029	Tendicinghia / Belt Tensioner - F1AE0481 DAILY 35C10/S10
LEM7PK1322L	1	5802102050	Cinghia Poly-V / V-ribbed belt - POLI-V HEAVYBELT
631210	1	16691424	Bullone/Vite / Screw - Vite testa esag. / Hexagon screw - CURSOR 8/9 BUS

HB405K

Kit cinghie dentate / Timing Belt Set

Suitable for: IVECO - 8140.67F/43S/B/N/R/K - 152RHDS300



DUBHE REF.	Q.TY	OE REF.	Descrizione / Description
HB310	1	500042740	Galoppino/Guidacinghia / Deflection/Guide Pulley - 8140/G9U DAILY/DUCATO/MASTER 2.8/2.5
HB246	1	2997797	Galoppino/Guidacinghia / Deflection/Guide Pulley - 8140/G9U DAILY/DUCATO/MASTER 2.8/2.5
293025	1	2997807	Cinghia dentata / Timing Belt - 8140 DAILY/DUCATO 2.8/2.5 152 X 30

HB410K

Kit cinghie dentate / Timing Belt Set

Suitable for: IVECO - 8140.23/43/43C - 154RHDS300



DUBHE REF.	Q.TY	OE REF.	Descrizione / Description
HB246	2	2997797	Galoppino/Guidacinghia / Deflection/Guide Pulley - 8140/G9U DAILY/DUCATO/MASTER 2.8/2.5
293045	1	500055908	Cinghia dentata / Timing Belt - 8140 DAYLY/DUCATO 2.5TDI/2.8TD 154X30

Suitable for **IVECO**

Adatto a **IVECO**

HB415K

Kit cinghie dentate / Timing Belt Set

Suitable for: IVECO - KIT DIST.8140.07/21/27S/47/63 - 153RHDS300
Dente 5,5 mm / Tooth 5.5 mm



DUBHE REF.	Q.TY	OE REF.	Descrizione / Description
HB246	2	2997797	Galoppino/Guidacinghia / Deflection/Guide Pulley - 8140/G9U DAILY/DUCATO/MASTER 2.8/2.5
293035	1	500323627	Cinghia dentata / Timing Belt - 8140.07/27/47 DAILY I/II

HB420K

Kit Cinghie Poly-V / V-Ribbed Belt Set

Suitable for: IVECO - F4AE0682/F4AE3682Y



DUBHE REF.	Q.TY	OE REF.	Descrizione / Description
HB210	1	4891116	Tendicinghia per Cinghia Poly-V / Belt Tensioner, V-ribbed belt F4AFE612/F4AE368 EUROFIRE/EUROCARGO
HB214	1	504065877	Galoppino/Guidacinghia / Deflection/Guide Pulley - F4AE0482/3482/F4AE0682/3682 TECTOR
HB218	1	504065878	Galoppino/Guidacinghia / Deflection/Guide Pulley - F4AEE681G TECTOR/EUROCARGO
LEM8PK1230L	1	5802350474	Cinghia Poly-V / V-ribbed belt - POLI-V HEAVYBELT

HB425K

Kit cinghie dentate / Timing Belt Set

Suitable for: IVECO - 8140.07/21/27S - 153RHX300
Dente 4,5 mm / Tooth 4.5 mm

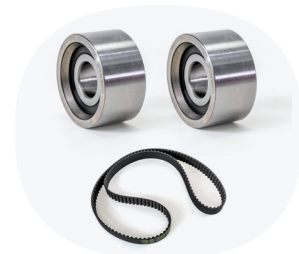

DUBHE REF.	Q.TY	OE REF.	Descrizione / Description
HB246	2	2997797	Galoppino/Guidacinghia / Deflection/Guide Pulley - 8140/G9U DAILY/DUCATO/MASTER 2.8/2.5
381005	1	4751143	Cinghia dentata / Timing Belt - 153RHX300 - Dente 4,5 mm / Tooth 4.5 mm

Suitable for **IVECO**

Adatto a **IVECO**

HB430K

Kit Cinghie Poly-V / V-Ribbed Belt Set

Suitable for: IVECO - DAILY S2000 CLIMA



DUBHE REF.	Q.TY	OE REF.	Descrizione / Description
HB306	1	500042993	Tendicinghia per Cinghia Poly-V / Belt Tensioner, V-ribbed belt - 8140.43 S DAILY I/III
LEM6PK1050L	1	500368902	Cinghia Poly-V / V-ribbed belt - POLI-V HEAVYBELT

Suitable for **RENAULT**

Adatto a **RENAULT**

HB500K

Kit Cinghie Poly-V / V-Ribbed Belt Set

Suitable for: RENAULT - DXI 11 KERAX/PREMIUM 2



DUBHE REF.	Q.TY	OE REF.	Descrizione / Description
HB222	2	7420739751	Tendicinghia per Cinghia Poly-V / Belt Tensioner, V-ribbed belt - D11/D12/D13 B/FH/FM/FMX SERIES
HB290	1	7408086970	Galoppino/Guidacinghia / Deflection/Guide Pulley - DXI 11 KERAX/PREMIUM 2
LEM8PK1526L	1	7422275090	Cinghia Poly-V / V-ribbed belt - POLI-V HEAVYBELT
LEM10PK1342L	1	7421190824	Cinghia Poly-V / V-ribbed belt - POLI-V HEAVYBELT

Suitable for **VOLVO**

Adatto a **VOLVO**

HB600K

Kit Cinghie Poly-V / V-Ribbed Belt Set

Suitable for: VOLVO - FH12/FM12/B12



DUBHE REF.	Q.TY	OE REF.	Descrizione / Description
HB270	1	8149855	Tendicinghia per Cinghia Poly-V / Belt Tensioner, V-ribbed belt D11A/B/C/K/D12A/C/D/D16C/E/G FM12 FH16 RENAULT MAGNUM
LEM8PK975L	1	7420715585	Cinghia Poly-V / V-ribbed belt - POLI-V HEAVYBELT



Indice tenditori e pulegge Tensioners and pulleys index.

*Per applicazione bus, veicoli commerciali leggeri e pesanti
Suitable for bus, LCV and HDV applications.*

	OE reference	Car maker	Description	Page
HB235	81832	CITROEN	Tendicinghia Belt tensioner	.11
HB236	00818.32	CITROEN	Tendicinghia Belt tensioner	.11
HB233	082965	CITROEN	Rullo tenditore Tensioner pulley	.11
HB232	4987964	CUMMINS	Tendicinghia Belt tensioner	.12
HB350	1398620	DAF	Tendicinghia Belt tensioner	.15
HB214	1399613	DAF	Galoppino/guidacinghia Deflection/Guide pulley	.13
HB232	1399691	DAF	Tendicinghia Belt tensioner	.14
HB294	1458924	DAF	Galoppino/guidacinghia Deflection/Guide pulley	.14
HB298	1627625	DAF	Tendicinghia Belt tensioner	.15
HB230	1653584	DAF	Tendicinghia Belt tensioner	.14
HB223	1699030	DAF	Galoppino/guidacinghia Deflection/Guide pulley	.13
HB218	1702527	DAF	Galoppino/guidacinghia Deflection/Guide pulley	.13
HB254	A5412002570	EVOBUS	Tendicinghia Belt tensioner	.16
HB233	4279745	FIAT	Rullo tenditore Tensioner pulley	.17
HB236	4740846	FIAT	Tendicinghia Belt tensioner	.17
HB235	7301661	FIAT	Tendicinghia Belt tensioner	.17
HB310	7301662	FIAT	Galoppino/Guidacinghia Deflection/Guide pulley	.18
HB302	500388688	FIAT	Galoppino/Guidacinghia Deflection/Guide pulley	.93

	OE reference	Car maker	Description	Page
HB258	504000412	FIAT	Galoppino/Guidacinghia Deflection/Guide pulley	.93
HB314	504086751	FIAT	Tendicinghia per Cinghia Poly-V Belt Tensioner, V-ribbed belt	.93
HB238	5802473355	FIAT	Rullo tenditore Tensioner pulley	.93
HB211	1704066	FORD	Tenditore Tensioner	.19
HB246	2997797	IVECO	Galoppino/Guidacinghia Deflection/Guide pulley	.27 / .94 / .95
HB233	4279745	IVECO	Rullo tenditore Tensioner pulley	.23
HB237	4616156	IVECO	Tendicinghia Belt tensioner	.25
HB241	4803462	IVECO	Tendicinghia Belt tensioner	.26
HB235	7301661	IVECO	Tendicinghia Belt tensioner	.24
HB236	7301662	IVECO	Tendicinghia Belt tensioner	.24
HB239	98429701	IVECO	Galoppino/guidacinghia Deflection/Guide pulley	.25
HB243	98436012	IVECO	Tendicinghia Belt tensioner	.26
HB310	500042740	IVECO	Galoppino/Guidacinghia Deflection/Guide pulley	.29 / .94
HB306	500042993	IVECO	Tendicinghia Belt tensioner	.28 / .96
HB244	500301088	IVECO	Tendicinghia Belt tensioner	.27
HB302	500388688	IVECO	Galoppino/Guidacinghia Deflection/Guide pulley	.28
HB258	504000412	IVECO	Galoppino/Guidacinghia Deflection/Guide pulley	.94
HB242	504006261	IVECO	Galoppino/guidacinghia Deflection/Guide pulley	.26
HB234	504046191	IVECO	Tendicinghia Belt tensioner	.24

	OE reference	Car maker	Description	Page
HB214	504065877	IVECO	Galoppino/guidacinghia Deflection/Guide pulley	.23 / .95
HB218	504065878	IVECO	Galoppino/guidacinghia Deflection/Guide pulley	.23 / .95
HB274	504072744	IVECO	Tendicinghia Belt tensioner	.28
HB314	504086751	IVECO	Tendicinghia Belt tensioner	.29 / .94
HB250	504086948	IVECO	Tendicinghia Belt tensioner	.27
HB354	504106749	IVECO	Tendicinghia Belt tensioner	.30
HB205	504106751	IVECO	Galoppino/guidacinghia Deflection/Guide pulley	.21
HB326	504153873	IVECO	Tendicinghia Belt tensioner	.29
HB210	504315785	IVECO	Tendicinghia Belt tensioner	.22 / .95
HB203	504315786	IVECO	Tendicinghia Belt tensioner	.21
HB206	504356034	IVECO	Tendicinghia Belt tensioner	.22
HB204	504356836	IVECO	Tendicinghia Belt tensioner	.21
HB209	5801404997	IVECO	Tendicinghia Belt tensioner	.22
HB200	5801405072	IVECO	Tendicinghia Belt tensioner	.20
HB338	5801674387	IVECO	Galoppino/guidacinghia Deflection/Guide pulley	.30
HB202	5801708165	IVECO	Galoppino/Guidacinghia Deflection/Guide pulley	.20
HB238	5802473355	IVECO	Rullo tenditore Tensioner pulley	.25
HB243	98436012	IVECO	Tendicinghia Belt tensioner	.26

	OE reference	Car maker	Description	Page
HB221	51.95800-6099	MAN	Tendicinghia Belt tensioner	.31
HB220	51.95800-7385	MAN	Tendicinghia Belt tensioner	.31
HB212	51.95800-7428	MAN	Tendicinghia Belt tensioner	.31
HB231	4572001470	MERCEDES	Tendicinghia Belt tensioner	.34
HB225	A0002001070	MERCEDES	Tendicinghia Belt tensioner	.34
HB224	A0005500833	MERCEDES	Galoppino/guidacinghia Deflection/Guide pulley	.33
HB213	A4572001970	MERCEDES	Tendicinghia Belt tensioner	.32
HB215	A5412000870	MERCEDES	Tendicinghia Belt tensioner	.33
HB254	A5412001070	MERCEDES	Tendicinghia Belt tensioner	.34
HB216	A9062000470	MERCEDES	Galoppino/guidacinghia Deflection/Guide pulley	.33
HB208	A9062004570	MERCEDES	Tendicinghia Belt tensioner	.32
HB207	A9062004670	MERCEDES	Tendicinghia Belt tensioner	.32
HB233	9108200	OPEL	Rullo tenditore Tensioner pulley	.35
HB235	81832	PEUGEOT	Tendicinghia Belt tensioner	.36
HB233	82965	PEUGEOT	Rullo tenditore Tensioner pulley	.36
HB236	00818.32	PEUGEOT	Tendicinghia Belt tensioner	.36
HB270	8149855	RENAULT	Tendicinghia Belt tensioner	.39
HB236	5001001259	RENAULT	Tendicinghia Belt tensioner	.38

	OE reference	Car maker	Description	Page
HB233	5001001263	RENAULT	Rullo tenditore <i>Tensioner pulley</i>	.38
HB310	5001001272	RENAULT	Galoppino/Guidacinghia <i>Deflection/Guide pulley</i>	.40
HB286	5010412957	RENAULT	Tendicinghia <i>Belt tensioner</i>	.40
HB290	7408086970	RENAULT	Galoppino/guidacinghia <i>Deflection/Guide pulley</i>	.40 / .97
HB278	7420487079	RENAULT	Tendicinghia <i>Belt tensioner</i>	.39
HB226	7420521447	RENAULT	Galoppino/guidacinghia <i>Deflection/Guide pulley</i>	.37
HB227	7420759364	RENAULT	Galoppino/guidacinghia <i>Deflection/Guide pulley</i>	.37
HB222	7420935521	RENAULT	Tendicinghia <i>Belt tensioner</i>	.37 / .97
HB266	7421257889	RENAULT	Tendicinghia <i>Belt tensioner</i>	.39
HB235	7701040204	RENAULT	Tendicinghia <i>Belt tensioner</i>	.38
HB219	1510697	SCANIA	Galoppino/guidacinghia <i>Deflection/Guide pulley</i>	.41
HB330	1774652	SCANIA	Tendicinghia <i>Belt tensioner</i>	.41
HB346	1774653	SCANIA	Tendicinghia <i>Belt tensioner</i>	.42
HB217	2197005	SCANIA	Tendicinghia <i>Belt tensioner</i>	.41
HB290	8086970	VOLVO	Galoppino/guidacinghia <i>Deflection/Guide pulley</i>	.45
HB227	21390528	VOLVO	Galoppino/guidacinghia <i>Deflection/Guide pulley</i>	.43
HB266	21257889	VOLVO	Tendicinghia <i>Belt tensioner</i>	.44
HB227	21390528	VOLVO	Galoppino/guidacinghia <i>Deflection/Guide pulley</i>	.43

	OE reference	Car maker	Description	Page
HB222	21422765	VOLVO	Tendicinghia Belt tensioner	.43
HB228	21631484	VOLVO	Tendicinghia Belt tensioner	.44
HB226	21766717	VOLVO	Galoppino/guidacinghia Deflection/Guide pulley	.43
HB270	8149855	VOLVO	Tendicinghia per Cinghia Poly-V Belt Tensioner, V-ribbed belt	.97

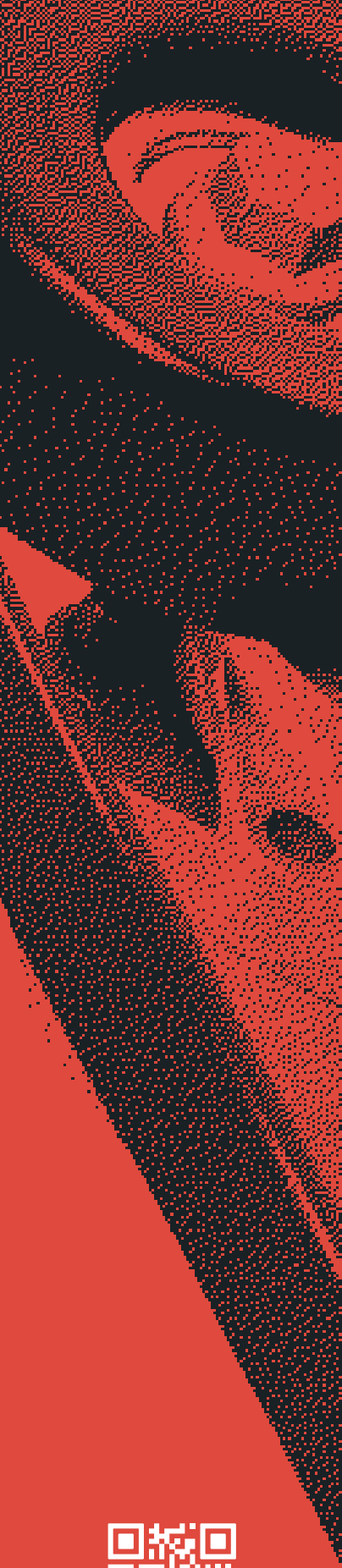

La costante ricerca dei migliori prodotti sul mercato e l'elevata competenza tecnica ci hanno permesso di realizzare un catalogo interamente dedicato alle componenti che rivestono un ruolo centrale nella manutenzione straordinaria del veicolo. Trova facilmente cinghie, pulegge e tenditori grazie alla ricerca per foto e per codice OEM.

Our technical expertise and the ongoing research of the best possible product have led to the development of a catalogue entirely focused on components that play a central role in the extraordinary maintenance of vehicles. Get the easiest and fastest search possibile by using the photographic and OEM indexes.

Distributore ufficiale in Italia

Dubhe S.r.l.
Via Sestriere, 3 - 10060 Candiolo (TO) - Italy
+39 011 397.21.32
sales@dubhegroup.com

Official distributor abroad

Le.ma S.r.l.
Via del vetraio, 26 - 40138 Bologna (BO) - Italy
+39 051 603.01.11
export@lema-part.it



Dubhe S.r.l.
E-commerce

**HEAVY
BELT**

LEMA[®]
TRUCKS & BUSES SPARE PARTS

HeavyBelt è un marchio registrato di Le.Ma S.r.l.
HeavyBelt is a Le.Ma S.r.l registered brand.