



Kit catena distribuzione.

Timing chain kit.
Kit de chaîne de distribution.
Kit de cadena de distribución.
Steuerkettensatz.



ITA

Il marchio **Mec-Diesel**, nato nel 1983, da subito si specializza nei ricambi per motori. Con il passare degli anni, si concentra sullo sviluppo di componenti essenziali per i motori endotermici, mantenendo elevati standard qualitativi grazie a investimenti in ricerca e selezione accurata dei fornitori.

Mec-Diesel è un marchio distribuito da Dubhe Srl.

Dubhe è il distributore italiano specializzato in parti di ricambio per autocarro, veicolo commerciale, bus e rimorchio, con una forte specializzazione sui ricambi motore, cambio e differenziale. Con oltre 50 anni di esperienza, il gruppo Dubhe offre ai propri clienti una vasta gamma di prodotti sia con marchio proprio che premium.

Grazie all'ampia conoscenza tecnica, produttiva e commerciale delle aziende fondatrici, (Mec-Diesel S.r.l., C.E.I. Costruzione Emiliana Ingranaggi S.p.A. e Lema S.r.l.) Dubhe garantisce elevati standard qualitativi.

ENG

The brand, born in 1983, is specialised in engine spare parts. Over the years, it focuses on the development of essential components for internal combustion engines, maintaining high quality standards through investments in research and careful supplier selection.

Mec-Diesel is a private label distributed by Dubhe Srl.

Dubhe is the Italian distributor specialised in spare parts for trucks, commercial vehicles, buses and trailers, with a strong focus on engines, gearboxes, differentials and their components.

With over 50-years of history, Dubhe Group offers a wide product range under private labels and premium brands.

Thanks to the technical, production and commercial knowledge of the founding companies, (Mec-Diesel S.r.l., C.E.I. Construction Emiliana Ingranaggi S.p.A. and Lema S.r.l.), Dubhe ensures high quality standards.

Indice sezioni.
Section index

Sezione A Section A	Kit catena distribuzione Introduzione tecnica <i>Timing chain kit Technical introduction</i>	.7
	Kit catena distribuzione Elenco codici MEC-DIESEL <i>Timing chain kit MEC-DIESEL items list</i>	.33
Sezione B Section B	Kit catena distribuzione Indice per codice OE <i>Timing chain kit Index by OEM part number</i>	.113



Kit catena distribuzione Timing chain kit.

*Per applicazione vettura e veicolo commerciale leggero
Suitable for passenger car and LCV applications.*

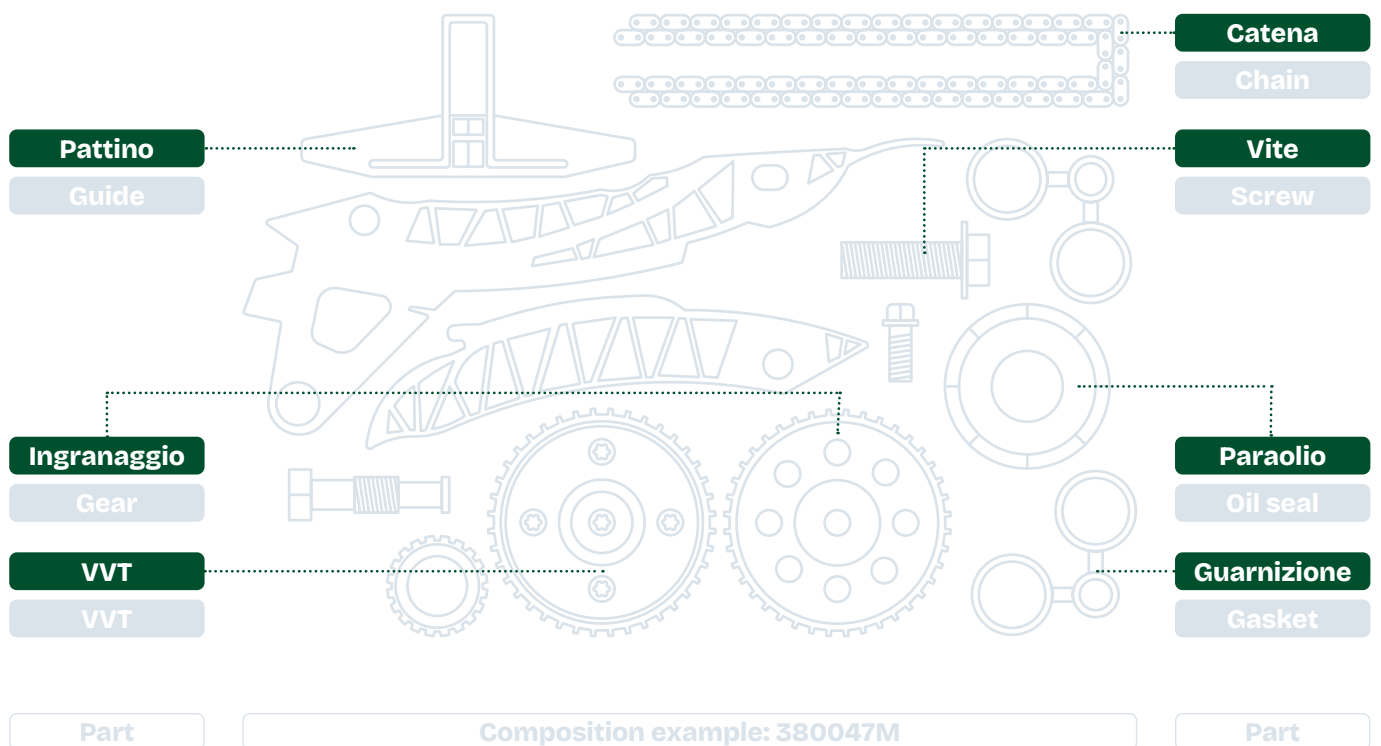

INFO TECNICHE TECHNICAL INFOS.

La distribuzione motore è l'insieme dei componenti che garantiscono la sincronizzazione fra l'albero motore e gli alberi a camme, permettendo la corretta apertura e chiusura delle valvole.

The engine timing system is the set of components that ensure synchronization between the crankshaft and camshafts, allowing the correct opening and closing of valves.

*The OE references and the pictures are for illustrative purpose.

KIT DISTRIBUZIONE

Pattini e guide: viene indicato il nr. parti
Guides: provided number of components



Ingranaggio: viene indicato il nr. denti
Gear: with given teeth number (if available)

Catena: viene indicata tipologia e nr. maglie
Chain: type and link number is specified

CATENA DISTRIBUZIONE

Oggi, sempre più veicoli a motore sono dotati della catena di distribuzione, poiché essa presenta due principali vantaggi:

- Alta capacità di carico (grande resistenza alla forza meccanica applicata anche dai motori di grandi dimensioni);
- Lunga durata: questo sistema di trasmissione tendenzialmente dura quanto il motore, se correttamente mantenuto.

TIMING CHAIN

Today, more and more motor vehicles are equipped with a timing chain, which offers two main advantages:

- High load capacity (great resistance to the mechanical force applied even by large engines);
- Long service life: this transmission system tends to last as long as the engine, if properly maintained.

I NOSTRI PRODOTTI OUR PRODUCTS.

I kit catena Mec-Diesel, disponibili per vettura e veicolo commerciale leggero, comprendono tutto il necessario per una riparazione professionale. Il prodotto a marchio Mec-Diesel è il risultato di un'attenta analisi del parco circolante e, grazie ai test applicati su banco prova, la gamma dei kit catena Mec-Diesel assicura qualità e durata pari al prodotto originale.

Mec-Diesel chain kits, available for passenger cars and light commercial vehicles, include everything required for a professional repair. The Mec-Diesel branded product is the result of a careful analysis of the existing stock. Thanks to the tests applied on the test bench, the range of Mec-Diesel chain kits ensures quality and durability equal to the original product.

CATENA DISTRIBUZIONE

Il principale indicatore di malfunzionamento della catena è la rumorosità eccessiva del motore che può essere accompagnata, nei casi più gravi, dall'accensione della spia motore sul quadro a causa della mancanza di sincronismo fra le componenti.

La catena si rompe quando viene sottoposta a carichi eccessivi o irregolari. La rottura può essere determinata dalla mancanza di tensione, dovuta ad una carenza di pressione idraulica all'interno del tendicatena oppure dal consumo del metallo dovuto all'abrasione che l'olio non conforme (con impurità) ha sul materiale.

Entrambi i casi sono riconducibili a:

- mancanza di lubrificazione;
- blocco dei condotti di lubrificazione;
- contaminazione del lubrificante;
- gradazione errata del lubrificante;
- difettosità della pompa del lubrificante.

TIMING CHAIN

The main indicator of chain malfunction is excessive engine noise, which can be accompanied, in severe cases, by the activation of the engine warning light on the dashboard due to the lack of synchronization between the components.

The chain breaks when subjected to excessive or irregular loads. The rupture can be caused by lack of tension, due to a deficiency of hydraulic pressure inside the tensioner, or by metal consumption due to abrasion caused by non-compliant (impure) oil on the material.

Both cases can be attributed to:

- Lack of lubrication;
- Blockage of lubrication ducts;
- Lubricant contamination;
- Incorrect lubricant grade;
- Defectiveness of the lubricant pump.



Esempio di materiale difettoso: 381980 adatto a 204DTD - DEFENDER/DISCOVERY 2.0
Example of faulty material: 381980 suitable for 204DTD - DEFENDER/DISCOVERY 2.0

Aggiornamenti sulla tecnologia di rivestimento Upgrade Coating Technology

Infiltrazione di Nitruro di Alluminio e Vanadio di 5° Generazione
Aluminum Nitride & 5th Generation Vanadium Infiltration

INTRODUZIONE: NITRURO DI ALLUMINIO E VANADIO

I prodotti **MEC DIESEL** utilizzano due diverse soluzioni di rivestimento per il perno delle catene, **Nitruro di Alluminio e Vanadio**. Queste due tecnologie di trattamento termico superficiale forniscono una **migliore durezza**, un **migliore spessore** al materiale in acciaio legato del perno, **migliorando la durata complessiva** e prolungando il ciclo di vita della catena.

- Eccellente durezza del rivestimento
- Spessore del rivestimento di 1° classe
- Alta resistenza all'usura
- Forte resistenza alla corrosione
- Eccezionale resistenza al carbonio
- Resistenza alla diluizione dell'olio

INTRODUCTION: ALUMINUM NITRIDE & VANADIUM

MEC DIESEL implements two different coating solution on the pin of chains, **Aluminum Nitride and Vanadium**. These two technologies of heat treatment provide **better hardness, better thickness to the alloy steel material of pin, improving the comprehensive durability as well as extending the life cycle of the chain.**

- Excellent Coating Hardness
- First-Class Coating Thickness
- High Wear Resistance
- Strong Corrosion Resistance
- Outstanding Carbon Resistance
- Prime Oil Dilution Resistance



Trattamento Superficiale: Nitruro di Alluminio Heat Treatment: Aluminum Nitride

La nitrurazione dell'alluminio è un processo chimico di **trattamento termico superficiale** che, controllando le condizioni di reazione, **fa reagire l'alluminio contenuto nel metallo del perno con gli atomi di azoto infiltrati**, formando uno strato denso di nitruro di alluminio (**AlN**). Grazie a questo aggiornamento, la catena risulterà più forte e migliorerà la sua capacità di resistenza alla corrosione.

Aluminum Nitriding is a chemical surface heat treatment process which, controlling the reaction conditions, makes the Aluminum contained in the pin metal **react with the infiltrated nitrogen atoms** to form a **dense Aluminum Nitride (AlN) layer**. This improvement makes the chain **stronger** and enhance its **corrosion resistance capabilities**.

PRINCIPIO DEL RIVESTIMENTO DI NITRURAZIONE DELL'ALLUMINIO ALUMINUM NITRIDING COATING PRINCIPLE

• Quando Metano e Ammoniaca reagiscono si genera **acido cianidrico** combinando il carbonio del metano e l'azoto dell'ammoniaca

*Methane and Ammonia reaction generates **Hydrogen cyanide** combining the carbon from the methane and the nitrogen from ammonia*

• L'acido cianidrico viene decomposto termicamente in **carbonio libero, azoto libero e idrogeno**.

*Hydrogen cyanide is thermally **decomposed** into **free carbon, free nitrogen and hydrogen***

• **L'azoto reagisce con l'alluminio** contenuto nella superficie riscaldata del materiale del perno e **genera lo strato di rivestimento in nitruro di alluminio**

Nitrogen reacts with Aluminum** contained in the heated surface of pin material and generates **the Aluminum Nitride coating layer

Miglioramenti del prodotto Product Improvements

- Elevata temprabilità
High hardenability
- Migliore resistenza al rinvenimento dello strato permeabile
Improved tempering resistance of permeable layer
- Migliore resistenza all'usura e alla fatica
Better wear and fatigue resistance

Applicazioni del prodotto Product Application

- Catena a boccola
Bushing Chain
- Catena a rulli
Roller Chain

Trattamento termico superficiale: Carbonitrurazione vs Nitrurazione dell' Alluminio Heat Treatment: Carbonitriding Vs Aluminum Nitriding

La Nitrurazione dell'Alluminio ha sostituito la carbonitrurazione come tecnica all'avanguardia per il rivestimento del perno. Il prodotto finito presenta come vantaggi una **elevata temprabilità, resistenza al rinvimento dello stato permeabile, una buona resistenza all'usura e resistenza alla fatica.**

Aluminum nitriding replaced Carbon nitriding as coating technique improvement. The finished product has the advantages of **high hardenability and tempering resistance of the permeable layer, good wear resistance and fatigue resistance.**

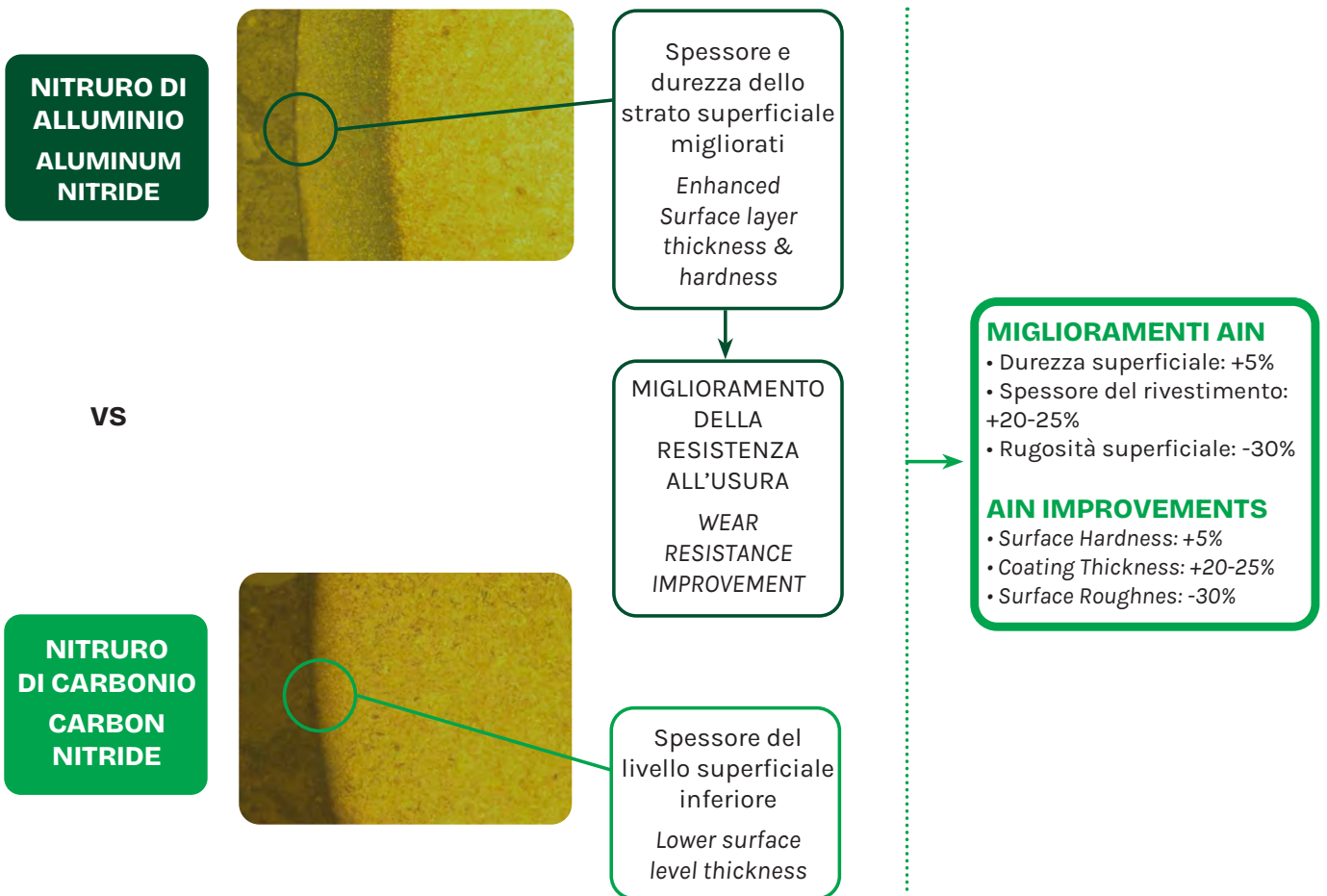

Lo spessore migliorato dello strato di nitruro di alluminio offre una migliore resistenza all'usura e prolunga il ciclo di vita della catena.

The improved thickness of the Aluminum nitride layer provides better wear resistance and extends chain life cycle.

Trattamento termico superficiale: Carburo di Vanadio Heat Treatment: Vanadium Carbide Layer

PRINCIPIO DEL RIVESTIMENTO AL VANADIO

- Il **cloruro di ammonio** (attivatore) si **decompone in ammoniaca e acido cloridrico** (HCl) al riscaldamento
- L'**ammoniaca** reagisce con il **Vanadio** precipitato generando **Cloruro di Vanadio (VC)**
- Ad alte temperature, VC forma uno strato di **carburo duro** che reagisce con il carbonio presente nel materiale in acciaio del perno.

VANADIUM COATING PRINCIPLE

- The **Ammonium chloride** decomposes into ammonia and hydrogen chloride (HCl) upon heating
- The **Ammonia** reacts with precipitated Vanadium generating **Vanadium chloride (VC)**
- At high temperatures, **VC** forms a **hard carbide layer reacting with carbon** present in the steel material of pin

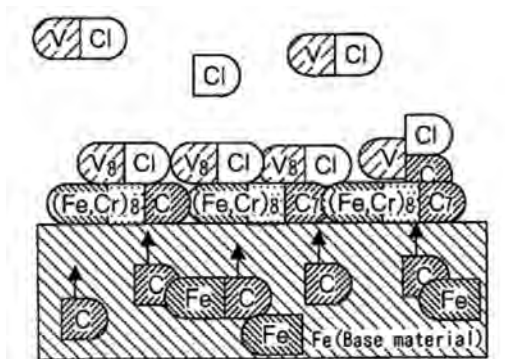

PROPRIETÀ DI RESISTENZA AGLI ACIDI

- Il **ferro** contenuto nella superficie dell'acciaio **reagisce facilmente con l'acido** e poi cade
- Lo **strato di VC** viene mantenuto perché **non reagisce con l'acido**
- La riduzione delle inclusioni nello strato superficiale di **Carburo di vanadio (VC)** aumenta la **resistenza agli acidi**
- Anche sotto corrosione, lo **strato VC** può mantenere una buona **anti-stripping e rugosità superficiale, rendendolo più resistente agli acidi**

ACID RESISTANCE PROPERTIES

- Iron contained in the surface of Steel **easily reacts with acid and then falls off**
- VC coated **layer is retained** because it does not react with acid
- The reduced inclusions on VC surface layer **increase acid resistance capabilities**
- Even under corrosion, **VC layer** can maintain **good anti-stripping and surface roughness, making it more acid-resistant**

Le inclusioni attirano l'acido e la corrosione
Inclusions attracts acid & corrosion

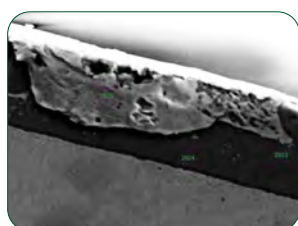

Lo strato superficiale migliorato previene la corrosione
Improved surface layer prevents corrosion

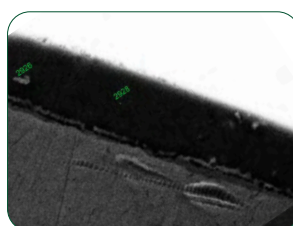

Trattamento termico superficiale: 5° vs 4° generazione Heat Treatment: The 5th Vanadium Vs The 4th Vanadium

La **5° generazione** della tecnologia di rivestimento al **vanadio** ha sostituito la 4° e fornisce miglioramenti al perno della catena sotto diverse proprietà chiave. La **rugosità del materiale è migliorata** e lo strato superficiale presenta meno inclusioni e più piccole rispetto alla generazione precedente.

The **5th generation of Vanadium coating technology replaced the 4th** and provides improvement to the chain pin under several key properties. The material **roughness is improved**, and the **surface layer presents fewer and smaller inclusions** compared with the previous generation.

5° GENERAZIONE VANADIO THE 5TH VANADIUM

VS

4° GENERAZIONE VANADIO THE 4TH VANADIUM

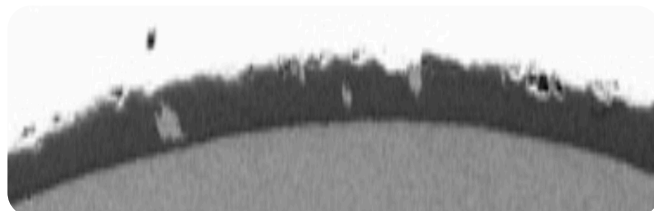
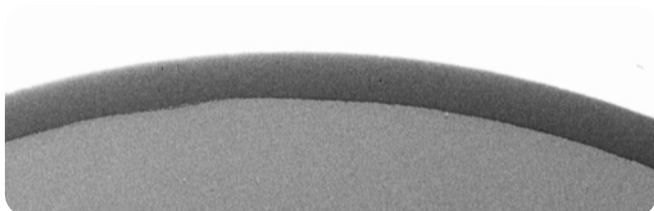

MIGLIORAMENTI 5° VANADIO

- Durezza superficiale: +11%
- Spessore del rivestimento: +30%
- Rugosità superficiale: -30%

V5 IMPROVEMENTS

- Surface Hardness: +11%
- Coating Thickness: +30%
- Surface Roughness: -30%

La tecnologia di rivestimento al vanadio di 5° generazione viene applicata al perno della catena silenzioso.
5th Generation of Vanadium coating technology is applied to Silent chain pin.

Test di comparazione contro OE Competitors Comparison tests vs OE Competitors

I risultati dei test
Tests Results

Catena dentata Rivestimento al Vanadio di 5^a generazione Silent Chain 5th Generation Vanadium coating

Confronto dei risultati dei test con azienda OE che utilizza la tecnologia di rivestimento a base di vanadio

Test result comparison vs OE Company using Vanadium-based coating technology

Confronto tra durezza dei perni e spessore del rivestimento Pin Hardness & coating layer thickness comparison

Elemento Di Misura Measurement item		Standard Standard	Dati Data									
Durezza superficiale Surface hardness	MEC DIESEL	≥1800HV0.2	2193	2186	2188	2179	2162	2189	2181	2198	2181	2183
	OE Company	≥1800HV0.2	2187	2174	2169	2182	2168	2173	2166	2162	2153	2154
Spessore di penetrazione Penetration thickness	MEC DIESEL	≥10µm	15.3	15.1	15.4	15.4	15.2	15.4	15.6	15.8	15.4	15.6
	OE Company	/	14.2	14.3	14.5	14.6	14.6	14.3	14.5	14.4	14.2	14.6

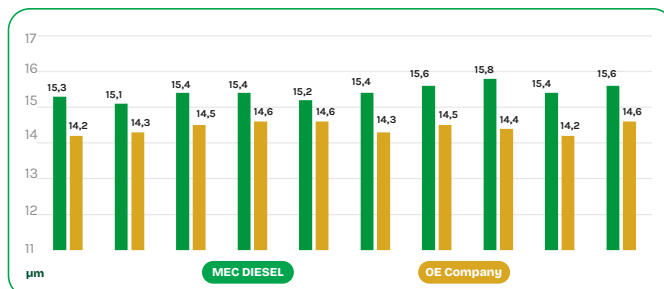
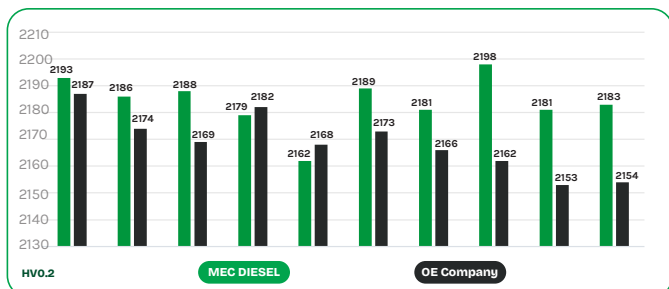

La durezza e la permeabilità del perno del prodotto MEC DIESEL sono coerenti con l'Azienda OE
The hardness and permeability of Mec Diesel pin shaft are consistent with that of OE Company

Confronto della rugosità del perno Pin Roughness comparison

Rugosità Roughness	OE Company					MEC DIESEL				
Rz _{≤0.5}	0,243	0,321	0,272	0,236	0,261	0,181	0,119	0,079	0,133	0,126
Superficie Surface										

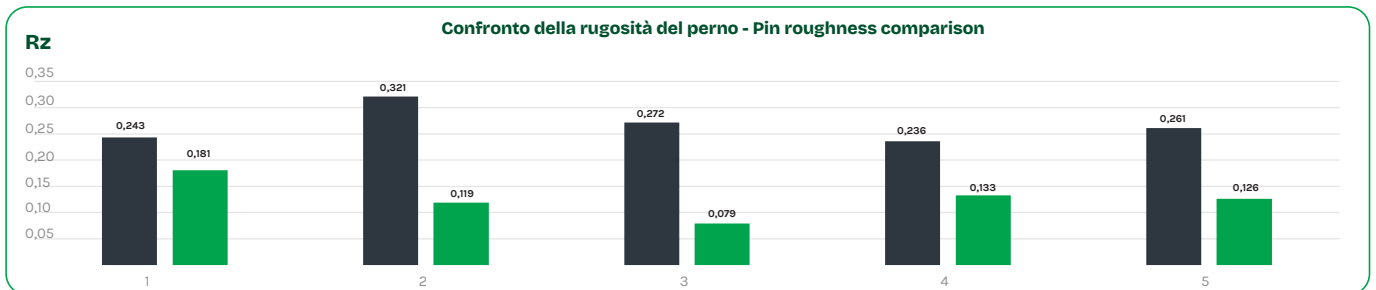

La rugosità dei prodotti MEC DIESEL è coerente con quella dell'azienda OE.
 The roughness of Mec Diesel products is consistent with that of OE Company.

Confronto della durezza della piastra Plate Hardness Comparison

Elemento Di Misura Measurement Item	Standard Standard	Dati Data						
Durezza superficiale Surface hardness	50-56HRC	53	53.5	52.5	53	52.5	53.5	
	OE Company	/	53	52.5	51.5	52	51.5	53

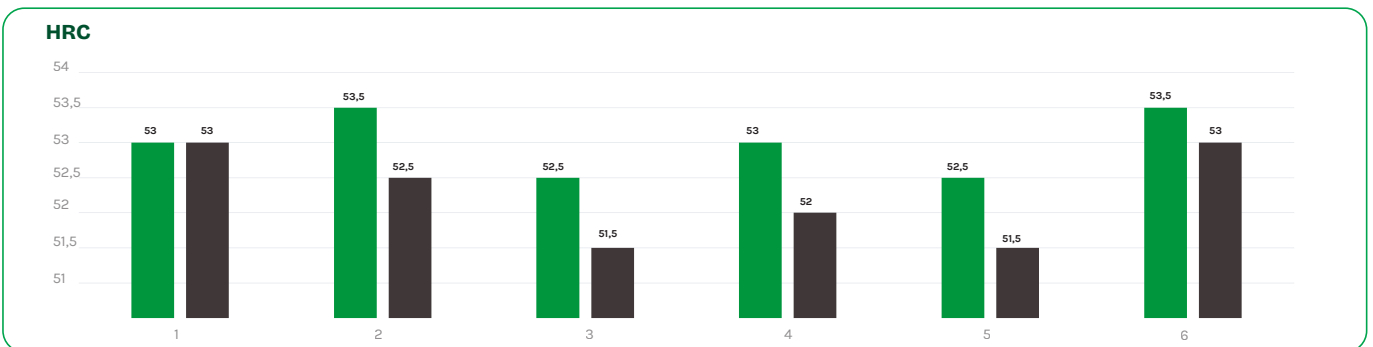

La durezza dei prodotti MEC DIESEL è coerente con quella dell'azienda OE.
 The plate hardness of Mec Diesel products is consistent with that of OE Company

*The OE references and the pictures are for illustrative purpose.

Prove dinamiche: Resistenza al carico di trazione
Dynamic testing: Tensile load strength

Lo scopo di questo test è quello di **garantire la durata meccanica e l'affidabilità del prodotto** della **catena di distribuzione**; l'idea è quella di determinare la capacità della catena di **resistere ai carichi di coppia di picco** impostando una forza minima richiesta (in questo caso 11 kN) durante il funzionamento del motore e la **capacità di sopportare gli elevati carichi di forza di allungamento** evitando allungamenti, rotture e deformazioni.

The purpose of this test is to **ensure mechanical durability and product reliability of the timing chain**; the idea is to determine the **chain capability to withstand peak torque loads** setting a minimum required force (in this case 11kN) during engine operation, and **ability to bear the high stretch force loads**, avoiding elongation, breakage and deformation.

CONDIZIONI TEST
TEST CONDITION

- **VELOCITA' DI CARICO:**
non oltre 20 mm/min
- **LOAD SPEED:**
not more than 20 mm/min
- **REQUISITI TARGET:**
non meno di 11kN
- **TARGET REQUIREMENTS:**
not less than 11 kN

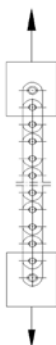

RISULTATO TEST
TESTING RESULT

	result(kN)	media average
	12.5/12.3/12.1	12.3
OE Company	12.4/12.3/12.1	12.3

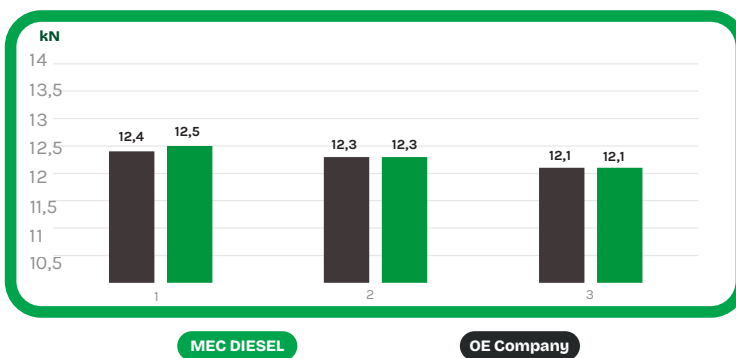

I carichi di rottura delle catene MEC DIESEL e OE Company sono sostanzialmente gli stessi.
The breaking loads of Mec Diesel and OE Company chains are basically the same

Test dinamici: Resistenza all'usura in ambiente di olio diluito
Dynamic Testing: Wear resistance in Oil Dilution Environment

Condizioni di prova Test Condition	
Velocità di corsa Running Speed	3000rpm
Forza di carico Load force	Bilateral 2500N
Lubrificazione Lubrication	1.4L/min, 0W20 oil +5% water+5% gasoline+1% nitric acid+0.15% carbon black, add 0.1% nitric acid every 20 hours

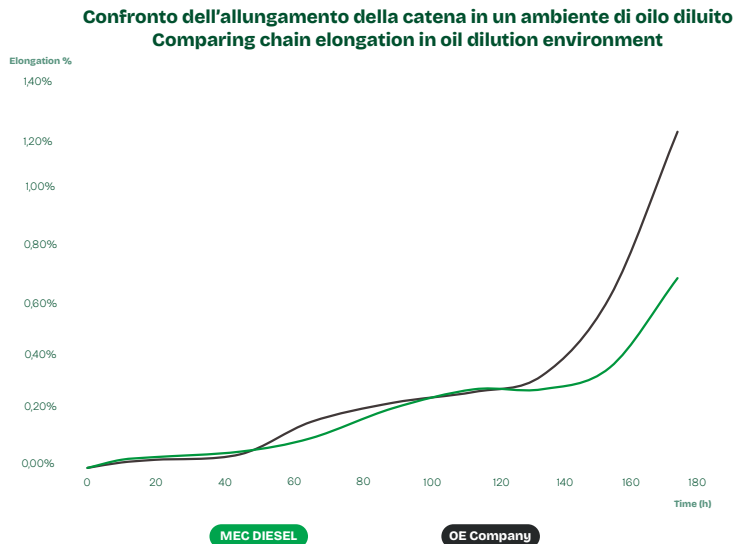

La catena MEC DIESEL mostra una migliore resistenza all'olio diluito rispetto all'azienda OE.
 Mec Diesel chain shows better Oil Dilution resistance compared to OE Company

*The OE references and the pictures are for illustrative purpose.

Catena a bocca

Rivestimento in Nitruro di Alluminio

Bush Chain

Aluminum Nitriding coating

Confronto dei risultati dei test con azienda OE che utilizza la tecnologia di rivestimento a base di cromo

Test result comparison vs OE Company using Chrome-based coating technology

Confronto tra durezza dei perni e spessore del rivestimento

Pin Hardness & coating layer thickness comparison

Elemento Di Misura Measurement item		Standard Standard	Dati Data									
Durezza superficiale MEC DIESEL	MEC DIESEL	≥697HV0.2	820	825	821	829	831	824	837	831	824	831
Surface hardness	OE Company	≥697HV0.2	845	833	841	834	835	816	819	835	831	815
Spessore di penetrazione MEC DIESEL	MEC DIESEL	≥50µm	137	124	133	124	142	128	120	136	133	120
Penetration thickness	OE Company	/	100	110	105	125	108	110	116	114	119	129

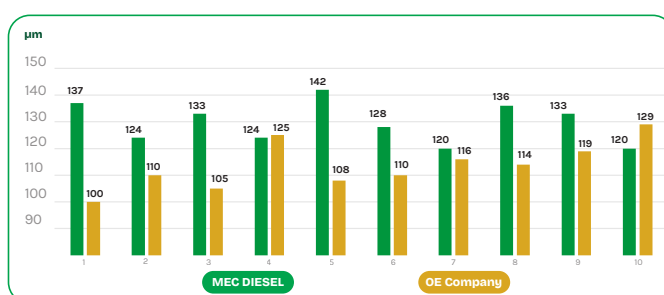
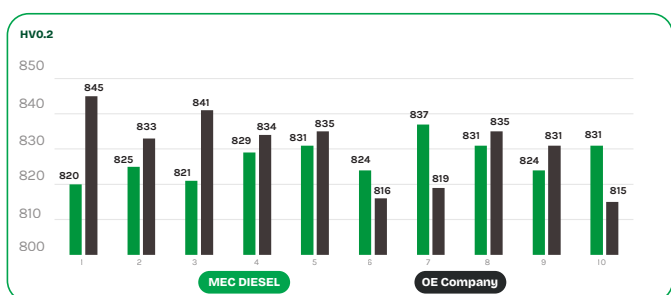

La durezza e la permeabilità del perno MEC DIESEL sono coerenti con l'Azienda OE.
The hardness and permeability of Mec Diesel pin shaft are consistent with that of OE Company

Confronto della rugosità del perno
Pin Roughness comparison

Rugosità Roughness	OE Company					MEC DIESEL				
Rz	0.3271	0.1935	0.2798	0.3379	0.2080	0.2749	0.3151	0.2181	0.2312	0.3176
Superficie Surface										

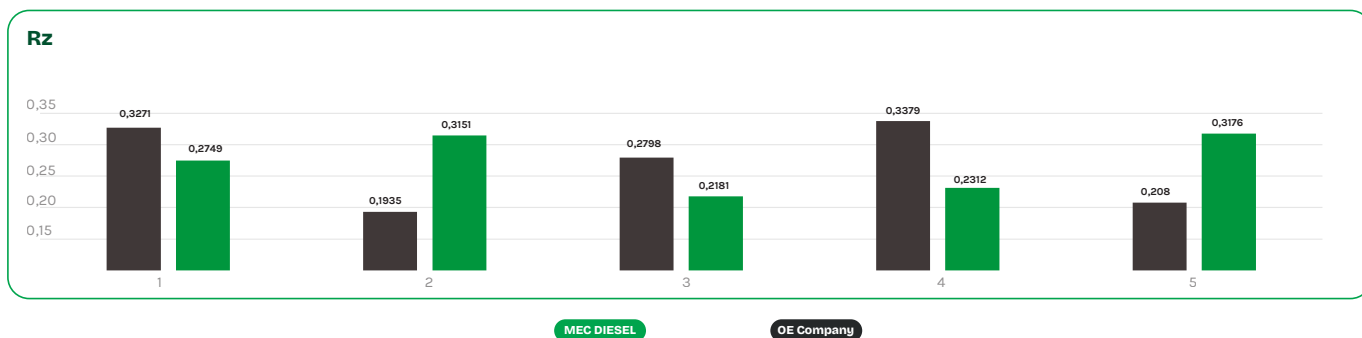

La rugosità dei prodotti MEC DIESEL è coerente con quella dell'azienda OE.
 The roughness of Mec Diesel products is consistent with that of OE Company

*The OE references and the pictures are for illustrative purpose.

Prove dinamiche: Resistenza al carico di trazione
Dynamic testing: Tensile load strength

Lo scopo di questo test è quello di **garantire la durata meccanica e l'affidabilità del prodotto** della **catena di distribuzione**; l'idea è quella di determinare la capacità della catena di **resistere ai carichi di coppia di picco** impostando una forza minima richiesta (in questo caso 8,5 kN) durante il funzionamento del motore e la **capacità di sopportare gli elevati carichi di forza di allungamento**, evitando allungamenti, rotture e deformazioni.

The purpose of this test is to **ensure mechanical durability and product reliability of the timing chain**; the idea is to determine the **chain capability to withstand peak torque loads** setting a minimum required force (in this case 8,5 kN) during engine operation, and **ability to bear the high stretch force loads**, avoiding elongation, breakage and deformation.

CONDIZIONI TEST
TEST CONDITION

- **VELOCITA' DI CARICO:**
non oltre 20 mm/min
- **LOAD SPEED:**
Not more than 20 mm/min
- **REQUISITI TARGET:**
non meno di 8,5kN
- **TARGET REQUIREMENTS:**
Not less than 8,5 kN



RISULTATO TEST
TESTING RESULT

	result(kN)	media average
	9.3/9.4/9.3	9.3
OE Company	9.4/9.4/9.3	9.4

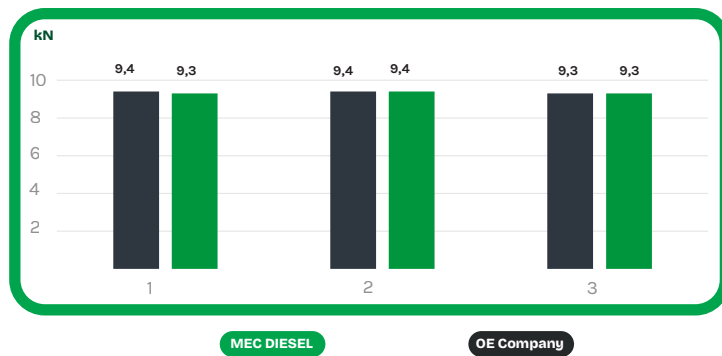

I carichi di rottura delle catene Mec Diesel e OE Company sono sostanzialmente gli stessi.
The breaking loads of MEC DIESEL and OE Company chains are basically the same

Test dinamici: Resistenza all'usura in ambiente di olio diluito
Dynamic Testing: Wear resistance in Oil Dilution Environment

Condizioni di prova Test Condition	
Velocità di corsa Running Speed	3000rpm
Forza di carico Load force	Bilateral 2500N
Lubrificazione Lubrication	1.4L/min, 0w20 new oil +5% water +5% gasoline, add 2% gasoline every 10h, add 1% water in 20h

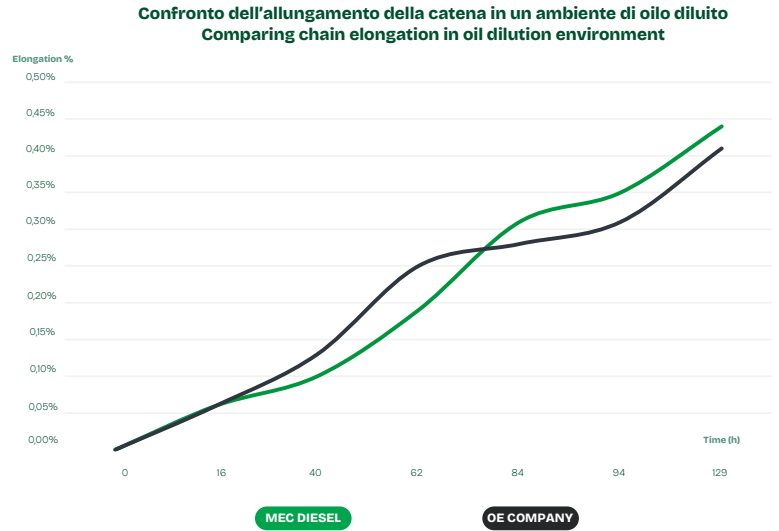

La catena a boccole MEC DIESEL mostra prestazioni di resistenza all'olio diluito coerenti con quelle dell'azienda OE.

Mec Diesel AIN bush chain shows Oil Dilution resistance performance consistent with that of OE Company

Test dinamici: Resistenza all'usura in ambiente di olio acidificato
Dynamic Testing: Wear resistance in Oil Acidification Environment

Condizioni di prova Test Condition	
Velocità di corsa Running Speed	3000rpm
Forza di carico Load force	Bilateral 2500N
Lubrificazione Lubrication	1.4L/min, 0W20+5% water +5% gasoline +1% nitric acid, 0.15% carbon black was added after 70 hours

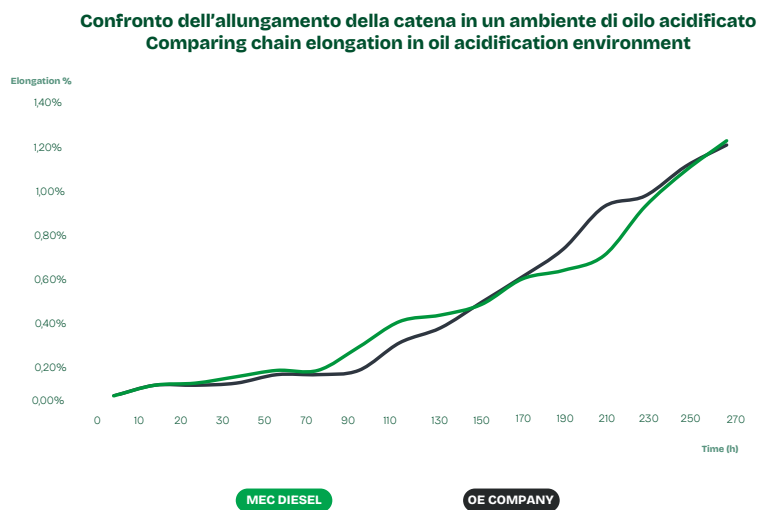

La catena a boccole MEC DIESEL mostra prestazioni di resistenza all'olio acidificato coerenti con quelle di OE Company.

Mec Diesel AIN bush chain shows Oil Acidification resistance performance consistent with that of OE Company

Prove dinamiche: Fatica rotazionale Dynamic Testing: Rotational fatigue

Lo scopo di questa prova è determinare **per quanto tempo la catena può resistere a forze di rotazione ripetute** durante le operazioni ad **alta velocità** prima di rompersi o raggiungere un allungamento superiore agli standard; Il test viene condotto applicando **sollecitazioni ripetitive sulla catena di distribuzione**, simulando la rotazione dei componenti del motore. Possono verificarsi guasti in termini di formazione di crepe sulle piastre, usura dei perni e rottura della catena.

The purpose of this test is to **determine how long the chain can resist repeated rotational forces during high-speed operations** before breakage or reaching an elongation above the standards; the test is conducted by **apply repetitive stress on the timing chain, simulating the rotation of engine components**. Failures may occur in terms of crack formation on the plates, pin wear and chain breakage.

CONDIZIONI DI PROVA TEST CONDITIONS

- **VELOCITÀ / SPEED:**
4500 giri/min
- **FORZA / FORCE:** 2000N
- **STATO DELL'OLIO / OIL CONDITION:**
1 m/min
- **TEMPO / TIME:** 400 ore

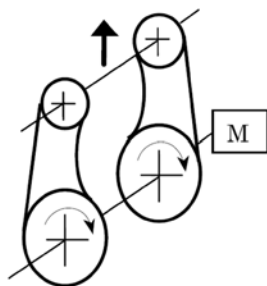

Rapporto del test di fatica della catena Chain fatigue test report									
ORE	0	50	100	150	200	250	300	350	400
MEC DIESEL (mm)	180.48	180.53	180.58	180.62	180.68	180.73	180.78	180.84	180.91
OE Company (mm)	180.50	180.54	180.58	180.61	180.67	180.73	180.78	180.82	180.89
MEC DIESEL elongation	0.00%	0.03%	0.06%	0.08%	0.11%	0.14%	0.17%	0.20%	0.24%
OE elongation	0.00%	0.02%	0.04%	0.06%	0.09%	0.13%	0.16%	0.18%	0.22%

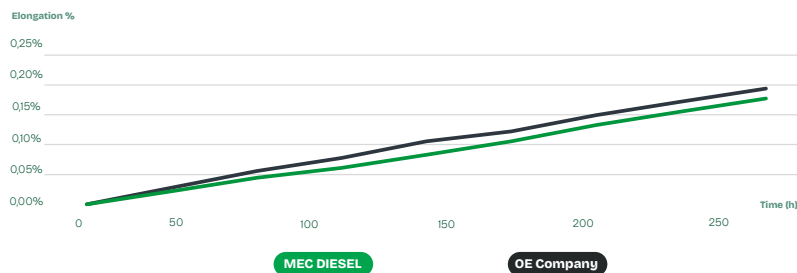

Entrambe le catene non si sono rotte e il valore di allungamento della catena MEC DIESEL risultante è coerente con quello di OE Company.



Both chains didn't break and the resulting MEC DIESEL chain elongation value is consistent with that of OE Company.

Catena a rulli Rivestimento in Nitruro di Alluminio Roller Chain Aluminum Nitriding coating

Confronto dei risultati dei test con azienda OE che utilizza la tecnologia di rivestimento in Nitruro di Carbonio.

Test result comparison vs OE Company using Carbon Nitriding coating technology.

Confronto tra durezza dei perni e spessore del rivestimento Pin Hardness & coating layer thickness comparison

Elemento Di Misura Measurement item		Standard Standard	Dati Data									
Durezza superficiale Surface hardness		≥697HV0.2	820	825	821	829	831	824	837	831	824	831
	OE Company	≥697HV0.2	815	819	832	834	835	816	819	835	831	815
Spessore di penetrazione Penetration thickness		≥50µm	137	124	133	124	142	128	120	136	133	120
	OE Company	/	100	110	105	125	108	110	116	114	119	129

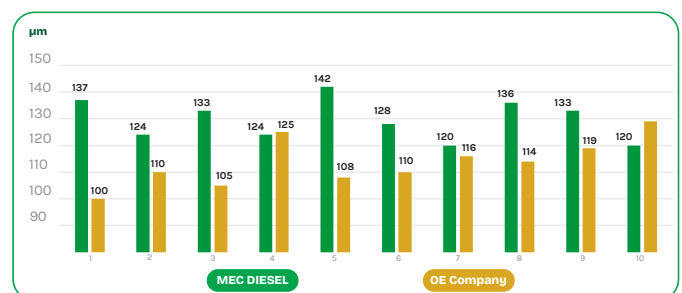
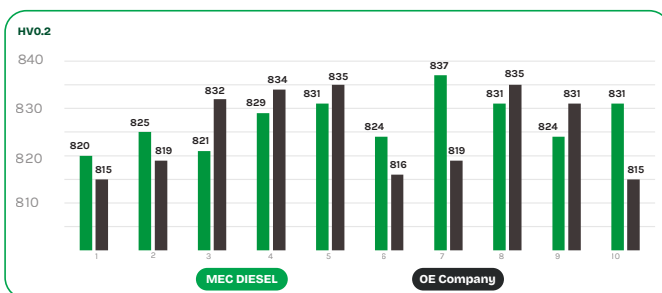

La durezza e la permeabilità del perno MEC DIESEL sono coerenti con l'Azienda OE.
 The hardness and permeability of Mec Diesel pin shaft are consistent with that of OE Company.

*The OE references and the pictures are for illustrative purpose.

Confronto della rugosità del perno
Pin Roughness comparison

Rugosità Roughness	OE Company					MEC DIESEL				
Rz≤0,5	0,431	0,392	0,462	0,387	0,439	0,351	0,379	0,421	0,364	0,417
Superficie Surface										

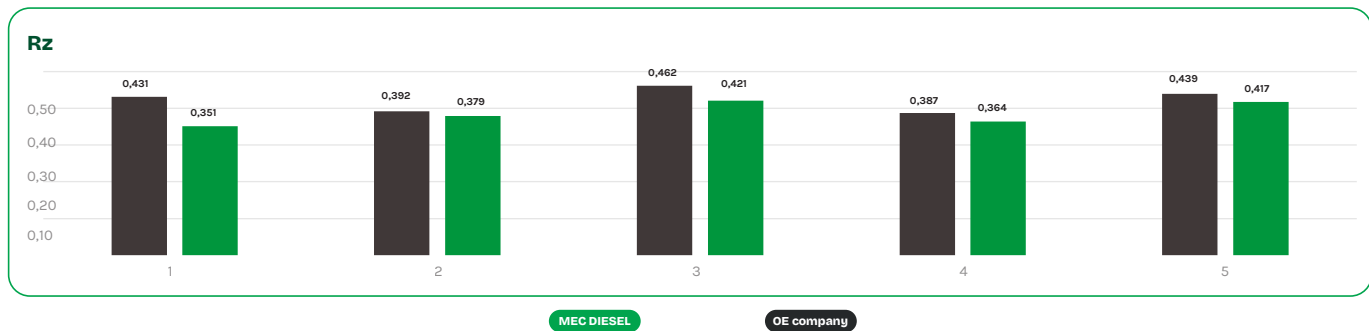

La rugosità dei prodotti MEC DIESEL è coerente con quella dell'azienda OE.
The roughness of Mec Diesel products is consistent with that of OE Company.

Prove dinamiche: Resistenza al carico di trazione Dynamic testing: Tensile load strength

Lo scopo di questo test è quello di **garantire la durata meccanica e l'affidabilità del prodotto** della **catena di distribuzione**; l'idea è quella di determinare la capacità della catena di **resistere ai carichi di coppia di picco** impostando una forza minima richiesta (in questo caso 8,5 kN) durante il funzionamento del motore e la **capacità di sopportare gli elevati carichi di forza di allungamento**, evitando allungamenti, rotture e deformazioni.

The purpose of this test is to **ensure mechanical durability and product reliability of the timing chain**; the idea is to determine the **chain capability to withstand peak torque loads** setting a minimum required force (in this case 8,5 kN) during engine operation, and **ability to bear the high stretch force loads**, avoiding elongation, breakage and deformation.

CONDIZIONI TEST TEST CONDITION

- **VELOCITA' DI CARICO:**
non oltre 20 mm/min
- **LOAD SPEED:**
Not more than 20 mm/min
- **REQUISITI TARGET:**
non meno di 8,5kN
- **TARGET REQUIREMENTS:**
Not less than 8,5 kN

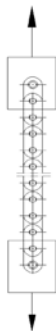

RISULTATO TEST TESTING RESULT

	result(kN)	media average
	10.5/10.5/10.4	10.4
OE Company	10.5/10.4/10.5	10.4

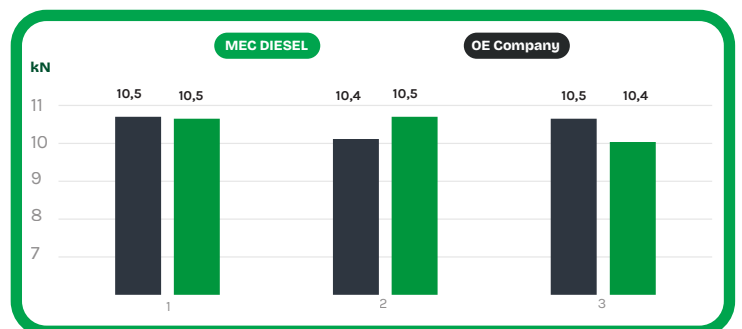

I carichi di rottura delle catene MEC DIESEL e OE Company sono sostanzialmente gli stessi.
 The breaking loads of Mec Diesel and OE Company chains are basically the same.

Test dinamici: Resistenza all'usura in ambiente di olio diluito
Dynamic Testing: Wear resistance in Oil Dilution Environment

Condizioni di prova Test Condition	
Velocità di corsa Running Speed	3000rpm
Forza di carico Load force	Bilateral 2500N
Lubrificazione Lubrication	Oil injection lubrication $\geq 1\text{L}/\text{min}$, maintenance replacement of waste oil, nitric acid (1g/L), water (1g/L)

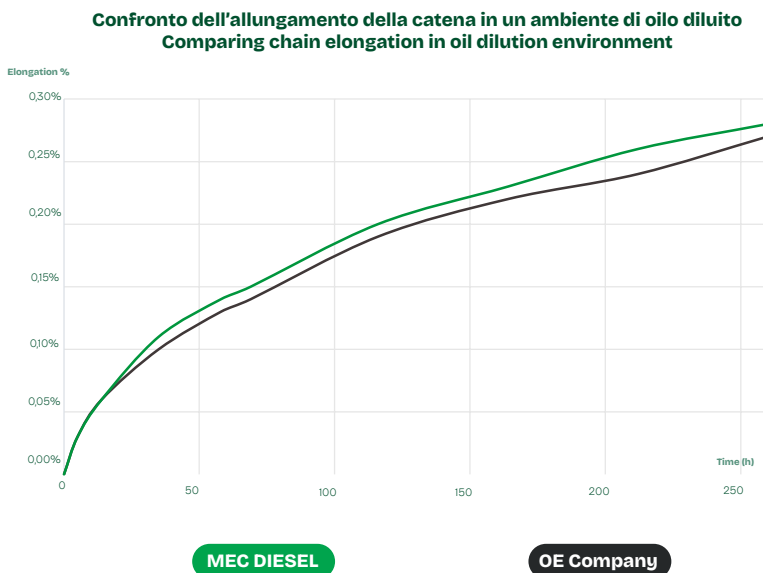

La catena a rulli MEC DIESEL mostra prestazioni di resistenza all'olio diluito coerenti con quelle dell'azienda OE.

MEC DIESEL AIN roller chain shows Oil Dilution resistance performance consistent with that of OE Company.

Suitable for **ALFA ROMEO**

Adatto a **ALFA ROMEO**

383105M

Cross Ref:

5636444 [ALFA ROMEO]

Suitable for:

MITO [Euro 4/5] - 1.3

199 A1.000 / 199 A3.000 / 199 B1.000 / 199 B4.000
199 B8.000 / 330 A1.000 / 955 B2.000

Components:

- x1 catena - chain
- x1 tenditore - tensioner
- x2 pattini/guide - guides
- x2 ingranaggi - gears
- x1 guarnizioni - gasket
- x1 paraolio - oil seal
- x7 viti - screws
- x1 ugello olio - oil feed pipe

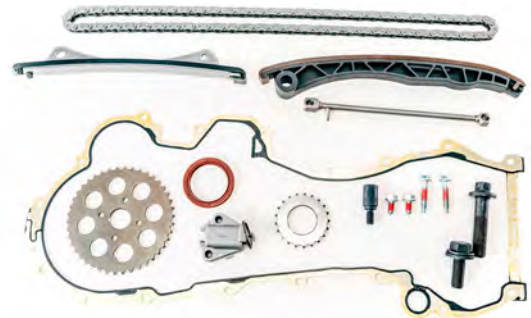

16 PEZZI - 16 PIECES

Technical information:

Catena semplice forata [chiusa] - 120 maglie
Closed simplex chain with lube-hole sleeves - 120 links

383216M

Cross Ref:

46788783 [ALFA ROMEO]

Suitable for:

MITO [Euro 4/5] - 1.3

199 A1.000 / 199 A3.000 / 199 B1.000 / 199 B4.000
199 B8.000 / 330 A1.000 / 955 B2.000

Components:

- x1 catena - chain
- x1 tenditore - tensioner
- x2 pattini/guide - guides
- x2 ingranaggi - gears
- x1 guarnizioni - gasket
- x1 paraolio - oil seal
- x1 ugello olio - oil feed pipe



9 PEZZI - 9 PIECES

Technical information:

Catena semplice [chiusa] - 120 maglie
Bush chain simplex [closed] - 120 links

Kit catena distribuzione Timing chain kit

Vetture e veicoli commerciali leggeri.
Passenger cars and light commercial vehicles

Adatto a **BWM - MINI**

Suitable for **BWM - MINI**

10 PEZZI - 10 PIECES



Complementary item:

960062 sigillante di tenuta - sealant

Technical information:

Catena semplice [chiusa] - 66/74 maglie
Bush chain simplex [closed] - 66/74 links

380015M

Cross Ref:

13528506969, 13527789690, 13522249852,
11318506869, 11312249851 [BMW]

Suitable for:

SERIE 1 / 3 / 5 / 6 / 7 / X3 / X5 / X6 - 2.0 / 3.0

M47 D20 / M57 D30 / M57 D25 / N57 306 D2 / N57 306 D3
N57N 306 D2 / N57N 306 D3 / N57N 306 D5

Components:

x2 catena - chain
x1 tenditore - tensioner
x4 pattini/guide - guides
x2 ingranaggi - gears
x1 paraolio - oil seal

13 PEZZI - 13 PIECES



Complementary item:

960062 sigillante di tenuta - sealant

Technical information:

Catena semplice [chiusa] - 144 maglie
Bush chain simplex [closed] - 144 links

380031M

Cross Ref:

11317516088, 11317534784, 11318618317 [BMW]

Suitable for:

CLUBMAN / COUPE / ROADSTER - 1.6

N14 B16 A / N14 B16 AB / N14 B16 C

Components:

x1 catena - chain
x1 tenditore - tensioner
x3 pattini/guide - guides
x2 ingranaggi - gears
x3 guarnizioni - gasket
x1 paraolio - oil seal
x2 viti - screws

Suitable for **BMW - MINI**

Adatto a **BMW - MINI**

380043M

Cross Ref:

11317797897 [BMW]

Suitable for:

BMW 1/2/3/4/5/6/7 - X1/3/5/6

2.0 - 3.0 B47 D20 A / M47 D20 (204D4) / M57 D30 (306D3)
M57N2 306 D3 / N47 C16 A / N47 C20 A / N47 D16 A
N47 D20 A / N47 D20 B / N47 D20 C / N47 D20 D
N47S D20 D / N57 D30 A / N57 D30 B / N57 D30 C

Components:

x1 catena - chain
x1 tenditore - tensioner
x2 pattini/guide - guides

4 PEZZI - 4 PIECES



Technical information:

Catena semplice [chiusa] - 86 maglie
Bush Chain simplex [closed] - 86 links

380046M

Cross Ref:

11310150552, 11311439853, 11318618318 [BMW]

Suitable for:

SERIE 1 / SERIE 3 - 1.6

N13 B16 A

Components:

x1 catena - chain
x1 tenditore - tensioner
x3 pattini/guide - guides
x7 guarnizioni - gasket
x1 paraolio - oil seal
x24 viti - screws

37 PEZZI - 37 PIECES



Complementary item:

960062 sigillante di tenuta - sealant

Technical information:

Catena semplice [chiusa] - 138 maglie
Bush chain simplex [closed] - 138 links

Kit catena distribuzione Timing chain kit

Vetture e veicoli commerciali leggeri.
Passenger cars and light commercial vehicles

Adatto a **BWM - MINI**

Suitable for **BWM - MINI**

15 PEZZI - 15 PIECES



Complementary item:

960062 sigillante di tenuta - sealant

Technical information:

Catena semplice [chiusa] - 144 maglie
Bush chain simplex [closed] - 144 links

380047M

Cross Ref:

11317516088, 11317534784, 11318618317 [BMW]

Suitable for:

CLUBMAN / COUPE / ROADSTER - 1.6

N14 B16 A / N14 B16 AB / N14 B16 C

Components:

x1 catena - chain
x1 tenditore - tensioner
x3 pattini/guide - guides
x2 ingranaggi - gears
x3 guarnizioni - gasket
x1 paraolio - oil seal
x3 viti - screws
x1 VVT

14 PEZZI - 14 PIECES



Complementary item:

960062 sigillante di tenuta - sealant

Technical information:

Catena semplice [chiusa] - 48/70/86 maglie
Bush chain simplex [closed] - 48/70/86 links

380683M

Cross Ref:

11417797896, 13528589971, 11318570649
13527797906, 13529886258 [BMW]

Suitable for:

SERIE 1 / 2 / X1 / X2 - 1.5 / 1.6

B37 C15 A / B37 D15 A / N47 C16 A

Components:

x3 catena - chain
x2 tenditore - tensioner
x4 pattini/guide - guides
x3 ingranaggi - gears
x1 paraolio - oil seal
x1 ugello olio - oil feed pipe

Suitable for **BMW - MINI**

Adatto a **BMW - MINI**

380685M

Cross Ref:

11318506650 [MINI]

Suitable for:

MINI CLUBMAN - 1.5

B37 C15 A / B37 D15 A

Components:

x3 catena - chain
x2 tenditore - tensioner
x4 pattini/guide - guides
x3 ingranaggi - gears
x1 paraolio - oil seal
x1 guarnizioni - gasket
x1 ugello olio - oil feed pipe

15 PEZZI - 15 PIECES



Technical information:

Catena semplice [chiusa] - 48/72/86 maglie
Bush Chain simplex [closed] - 48/72/86 links

380830M

Cross Ref:

11318572503 [BMW]

Suitable for:

BMW SERIE 3 - 3.0

N57 D30 A / N57 D30 B

Components:

x3 catena - chain
x2 tenditore - tensioner
x4 pattini/guide - guides
x2 ingranaggi - gears
x1 ugello olio - oil feed pipe

12 PEZZI - 12 PIECES



Complementary item:

960062 sigillante di tenuta - sealant

Technical information:

Catena semplice [chiusa] - 48/72/86 maglie
Bush Chain simplex [closed] - 48/72/86 links

Kit catena distribuzione Timing chain kit

Vetture e veicoli commerciali leggeri. Passenger cars and light commercial vehicles

Adatto a **BWM - MINI**

Suitable for **BWM - MINI**

13 PEZZI - 13 PIECES



Complementary item:

960062 sigillante di tenuta - sealant

Technical information:

Catena semplice [chiusa] - 48/70/86 maglie
Bush chain simplex [closed] - 48/70/86 links

384192M

Cross Ref:

11317797897, 11317797902, 11318506652, 11318570649
13528572504, 13528575471, 13529886258 [BMW]

Suitable for:

SERIE 1 - 5 / X1 / X3 / X5
CLUBMAN / COUNTRYMAN / PACEMAN / ROADSTER
1.6 / 2.0

N47 D16 A / N47 D20 A / N47 D20 B / N47 D20 C
N47 D20 D / N47 C16 A / N47 C20 A

Components:

x3 catena - chain
x2 tenditore - tensioner
x4 pattini/guide - guides
x2 ingranaggi - gears
x1 paraolio - oil seal
x1 ugello olio - oil feed pipe

14 PEZZI - 14 PIECES



Complementary item:

960062 sigillante di tenuta - sealant

Technical information:

Catena semplice [chiusa] - 48/68/86 maglie
Bush chain simplex [closed] - 48/68/86 links

384198M

Cross Ref:

11417797896, 13528576284, 11318570649,
13528490224 [BMW]

Suitable for:

SERIE 1 - 7 / X1 - X5
COUNTRYMAN / CLUBMAN - 2.0

B47 C20 A / B47 C20 B / B47 D20 A / B47 D20 B
B47 D20 O1

Components:

x3 catena - chain
x2 tenditore - tensioner
x4 pattini/guide - guides
x3 ingranaggi - gears
x1 paraolio - oil seal
x1 ugello olio - oil feed pipe

Suitable for **BMW - MINI**

Adatto a **BMW - MINI**

384975M

Cross Ref:

11318648729 [BMW]

Suitable for:

BMW - 1.5

B36 A15 A / B38 A15 A / B38 B15 A / B38 K15 A

Components:

x2 catena - chain
x2 tenditore - tensioner
x5 pattini/guide - guides
x1 ingranaggi - gears
x1 vite - screw

11 PEZZI - 11 PIECES



Technical information:

Catena semplice [chiusa] - 84/118 maglie
Bush Chain simplex [closed] - 84/118 links

385085M

Cross Ref:

11318570649 [BMW]

Suitable for:

BMW - 3.0

B57 D30 A / B57 D30 B / B57 D30 C

Components:

x3 catena - chain
x2 tenditore - tensioner
x4 pattini/guide - guides
x3 ingranaggi - gears
x1 paraolio - oil seal
x1 ugello olio - oil feed pipe

14 PEZZI - 14 PIECES



Technical information:

Catena semplice [chiusa] - 48/72/86 maglie
Bush Chain simplex [closed] - 48/72/86 links

Kit catena distribuzione Timing chain kit

Vetture e veicoli commerciali leggeri.
Passenger cars and light commercial vehicles

Adatto a **BWM - MINI**

Suitable for **BWM - MINI**

42 PEZZI - 42 PIECES

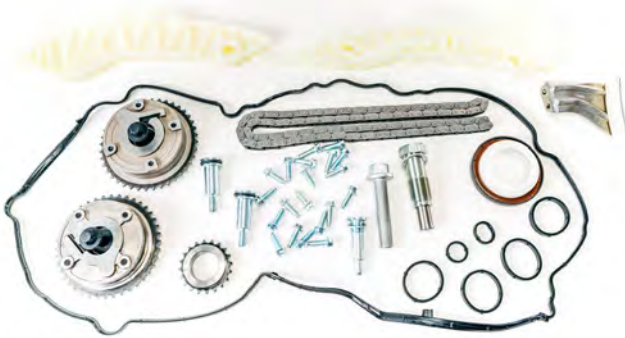

Complementary item:

960062 sigillante di tenuta - sealant

Technical information:

Catena semplice [chiusa] - 138 maglie
Bush chain simplex [closed] - 138 links

385678M

Cross Ref:

11318618318, 11311439853, 11310150552 [BMW]

Suitable for:

CLUBMAN / PACEMAN / COUNTRYMAN - 1.4 / 1.6

N12 B14 A / N12 B16 A / N16 B16 A

Components:

x1 catena - chain
x1 tenditore - tensioner
x3 pattini/guide - guides
x1 ingranaggi - gears
x7 guarnizioni - gasket
x1 paraolio - oil seal
x26 viti - screws
x2 VVT

Suitable for **DAIHATSU**

Adatto a **DAIHATSU**

380024

Cross Ref:

13506-B1010 [DAIHATSU]

Suitable for:

GRAN MAX / HIJET / MATERIA / TERIOS / SIRION - 1.5

3SZVE

Components:

- x1 catena - chain
- x1 tenditore - tensioner
- x3 pattini/guide - guides
- x2 ingranaggi - gears
- x1 paraolio - oil seal

8 PEZZI - 8 PIECES



Technical information:

Catena semplice [chiusa] - 132 maglie
Bush chain simplex [closed] - 132 links

Kit catena distribuzione Timing chain kit

Vetture e veicoli commerciali leggeri.
Passenger cars and light commercial vehicles

Adatto a **FIAT**

Suitable for **FIAT**

15 PEZZI - 15 PIECES



380067M

Cross Ref:

71739327 [FIAT]

Suitable for:

FIAT CROMA - 1.9 / 2.2

194 A1.000 / 939 A5.000 / 939 A6.000

Components:

- x1 catena - chain
- x1 tenditore - tensioner
- x3 pattini/guide - guides
- x1 ingranaggi - gears
- x1 paraolio - oil seal
- x1 guarnizioni - gasket
- x6 viti - screws
- x1 ugello olio - oil feed pipe

Technical information:

Catena semplice [chiusa] - 148 maglie
Bush Chain simplex [closed] - 148 links

8 PEZZI - 8 PIECES



38116M

Cross Ref:

55267975 [FIAT]

Suitable for:

FIAT - 1.0

463 41 162

Components:

- x1 catena - chain
- x1 tenditore - tensioner
- x3 pattini/guide - guides
- x2 ingranaggi - gears
- x1 paraolio - oil seal

Technical information:

Catena dentata [chiusa] - 148 maglie
Tooth chain [closed] - 148 links

Suitable for **FIAT**

Adatto a **FIAT**

381614M

Cross Ref:

9659438580, 9659486680 [FIAT]

Suitable for:

DUCATO - 2.2

4HV

Components:

- x1 catena - chain
- x1 tenditore - tensioner
- x3 pattini/guide - guides

5 PEZZI - 5 PIECES



Technical information:

Catena semplice [chiusa] - 122 maglie
Bush chain simplex [closed] - 122 links

382830M

Cross Ref:

504288857 [FIAT]

Suitable for:

DUCATO [Euro 1/2/3/4] - 3.0

FICE0441A / FICFA401A / FICFA401C

Components:

- x1 catena - chain
- x2 tenditore - tensioner
- x2 pattini/guide - guides
- x3 ingranaggi - gears

8 PEZZI - 8 PIECES



Technical information:

Catena semplice [chiusa] - 61 maglie
Bush chain simplex [closed] - 61 links

Kit catena distribuzione Timing chain kit

Vetture e veicoli commerciali leggeri.
Passenger cars and light commercial vehicles

Adatto a **FIAT**

Suitable for **FIAT**

8 PEZZI - 8 PIECES



382835M

Cross Ref:

5801375558 [FIAT]

Suitable for:

DUCATO [Euro 5] - 3.0

FICE0481D / FICE3481E / FICE3481M / FICE3481N

Components:

x1 catena - chain
x2 tenditore - tensioner
x2 pattini/guide - guides
x3 ingranaggi - gears

Technical information:

Catena semplice [chiusa] - 60 maglie
Bush chain simplex [closed] - 60 links

5 PEZZI - 5 PIECES



382980M

Cross Ref:

504161356, 5802009661 [FIAT]

Suitable for:

DUCATO [Euro 1/2/3/4] - 3.0

FICE0441A / FICFA401A / FICFA401C

Components:

x1 catena - chain
x2 pattini/guide - guides
x2 ingranaggi - gears

Technical information:

Catena duplex [chiusa] - 42 maglie
Bush chain duplex [closed] - 42 links

Suitable for **FIAT**

Adatto a **FIAT**

382995M

Cross Ref:

504294672 [FIAT]

Suitable for:

DUCATO [Euro 5] - 3.0

FICE0481D / FICE3481N / FICE3481E

Components:

- x1 catena - chain
- x2 pattini/guide - guides
- x2 ingranaggi - gears

5 PEZZI - 5 PIECES



Technical information:

Catena duplex [chiusa] - 41 maglie
Bush chain duplex [closed] - 41 links

383105M

Cross Ref:

55283520, 46788783, 55171579, 71777824 [FIAT]

Suitable for:

500 / DOBLO / FIORINO / PANDA / PUNTO / TIPO - 1.3

169 A1.000 / 169 A5.000 / 188 A8.000 / 188 A9.000
199 A1.000 / 199 A2.000 / 199 A3.000 / 199 A9.000
199 B1.000 / 199 B2.000 / 199 B4.000 / 199 B8.000
223 A9.000 / 225 A2.000 / 263 A2.000 / 263 A6.000
312 A8.000 / 312 B1.000 / 312 B2.000 / 312 B5.000

Components:

- x1 catena - chain
- x1 tenditore - tensioner
- x2 pattini/guide - guides
- x2 ingranaggi - gears
- x1 guarnizioni - gasket
- x1 paraolio - oil seal
- x7 viti - screws
- x1 ugello olio - oil feed pipe

16 PEZZI - 16 PIECES

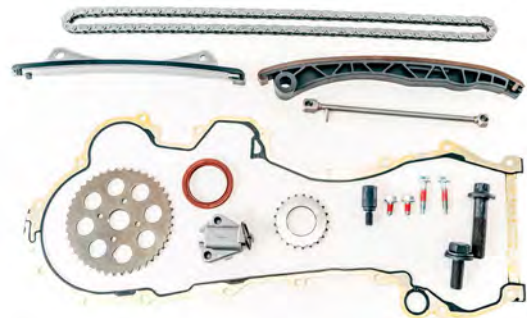

Technical information:

Catena semplice forata [chiusa] - 120 maglie
Closed simplex chain with lube-hole sleeves - 120 links

Kit catena distribuzione Timing chain kit

Vetture e veicoli commerciali leggeri.
Passenger cars and light commercial vehicles

Adatto a **FIAT**

Suitable for **FIAT**

19 PEZZI - 19 PIECES

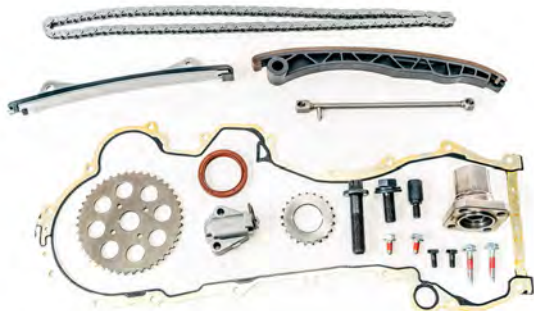

Technical information:

Catena semplice forata [chiusa] - 120 maglie
Closed simplex chain with lube-hole sleeves - 120 links

383106M

Cross Ref:

55283520, 55261264, 71777824 [FIAT]

Suitable for:

500 / DOBLO / FIORINO / PANDA / PUNTO / TIPO - 1.3
169 A1.000 / 169 A5.000 / 188 A8.000 / 188 A9.000
199 A1.000 / 199 A2.000 / 199 A3.000 / 199 A9.000
199 B1.000 / 199 B2.000 / 199 B4.000 / 199 B8.000
223 A9.000 / 225 A2.000 / 263 A2.000 / 263 A6.000
312 A8.000 / 312 B1.000 / 312 B2.000 / 312 B5.000

Components:

x1 catena - chain
x1 tenditore - tensioner
x2 pattini/guide - guides
x2 ingranaggi - gears
x1 guarnizioni - gasket
x1 paraolio - oil seal
x9 viti - screws
x1 ugello olio - oil feed pipe
x1 flangia - flange

8 PEZZI - 8 PIECES



Technical information:

Catena semplice [chiusa] - 120 maglie
Bush chain simplex [closed] - 120 links

383107

Cross Ref:

46788783, 55171579, 55261264, 71777824 [FIAT]

Suitable for:

DOBLO / FIORINO / 500 / PANDA / PUNTO / TIPO - 1.3
169 A1.000 / 169 A5.000 / 188 A8.000 / 188 A9.000
199 A1.000 / 199 A2.000 / 199 A3.000 / 199 A9.000
199 B1.000 / 199 B2.000 / 199 B4.000 / 199 B8.000
223 A9.000 / 225 A2.000 / 263 A2.000 / 263 A6.000
312 A8.000 / 312 B1.000 / 312 B2.000 / 312 B5.000

Components:

x1 catena - chain
x1 tenditore - tensioner
x2 pattini/guide - guides
x2 ingranaggi - gears
x1 guarnizioni - gasket
x1 paraolio - oil seal

Suitable for **FIAT**

Adatto a **FIAT**

383216M

Cross Ref:

71776647, 55195293, 55205448 [FIAT]

Suitable for:

500 / DOBLO / FIORINO / PANDA / PUNTO / TIPO
[Euro 4/5] - 1.3

169 A1.000 / 169 A5.000 / 188 A8.000 / 188 A9.000
199 A1.000 / 199 A2.000 / 199 A3.000 / 199 A9.000
199 B1.000 / 199 B2.000 / 199 B4.000 / 199 B8.000
223 A9.000 / 225 A2.000 / 263 A2.000 / 263 A6.000
312 A8.000 / 312 B1.000 / 312 B2.000 / 312 B5.000

Components:

- x1 catena - chain
- x1 tenditore - tensioner
- x2 pattini/guide - guides
- x2 ingranaggi - gears
- x1 guarnizioni - gasket
- x1 paraolio - oil seal
- x1 ugello olio - oil feed pipe

383300

Cross Ref:

504161356, 504288857 [FIAT]

Suitable for:

DUCATO [Euro 3/4] - 3.0

FICE0441A / FICE0481D / FICE3481E / FICE3481M
FICE3481N / FICFA401A

Components:

- x1 kit catena - timing kit **382830**
- x1 kit catena - timing kit **382980**
- x2 pattini/guide - guides
- x2 guarnizioni - gasket
- x1 paraolio - oil seal
- x1 viti - screws

9 PEZZI - 9 PIECES

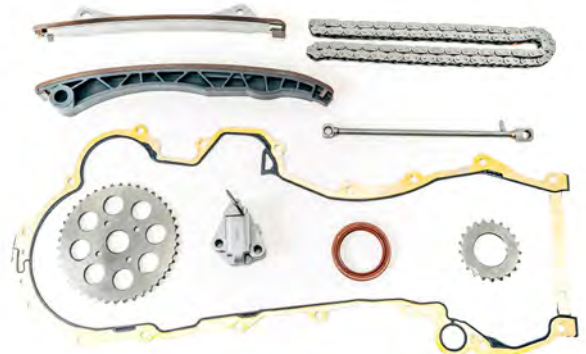

Technical information:

Catena semplice [chiusa] - 120 maglie
Bush chain simplex [closed] - 120 links

18 PEZZI - 18 PIECES



Technical information:

Catena semplice e duplex [chiusa] - 61/42 maglie
Bush chain simplex and duplex [closed] - 61/42 links

Kit catena distribuzione Timing chain kit

Vetture e veicoli commerciali leggeri.
Passenger cars and light commercial vehicles

Adatto a **FIAT**

Suitable for **FIAT**

10 PEZZI - 10 PIECES



Complementary item:

960062 sigillante di tenuta - sealant

Technical information:

Catena semplice [chiusa] - 122 maglie
Bush chain simplex [closed] - 122 links

383320M

Cross Ref:

9659438580 [FIAT]

Suitable for:

DUCATO - 2.2

4HG / 4HH / 4HJ / 4HU / 4HV

Components:

x1 catena - chain
x1 tenditore - tensioner
x3 pattini/guide - guides
x3 ingranaggi - gears
x1 guarnizioni - gasket
x1 paraolio - oil seal

18 PEZZI - 18 PIECES



Technical information:

Catena duplex [chiusa] - 41/60 maglie
Bush chain duplex [closed] - 41/60 links

383500

Cross Ref:

5801375558, 504310252 [FIAT]

Suitable for:

DUCATO [Euro 5] - 3.0

FICE3481 / FICFL411 / FICGL411 / FICE0481D / FICE3481E
FICE3481M / FICE3481N

Components:

x1 kit catena - timing kit **382995**
x1 kit catena - timing kit **382835**
x2 pattini/guide - guides
x2 guarnizioni - gasket
x1 paraolio - oil seal
x1 viti - screws

Suitable for **FIAT**

Adatto a **FIAT**

383503M

Cross Ref:

5802122595 [FIAT]

Suitable for:

DUCATO [Euro 5/6] - 3.0

FICE0481D / FICE3481N / FICE3481E

Components:

x2 pattini/guide - *guides*
x1 viti - *screws*

3 PEZZI - 3 PIECES



Technical information:

383580M

Cross Ref:

1231280, 1231282 [FIAT]

Suitable for:

SCUDO - 1.6

9H07 / 9HM / 9HU

Components:

x1 catena - *chain*
x1 tenditore - *tensioner*
x13 guarnizioni - *gasket*
x1 paraolio - *oil seal*

16 PEZZI - 16 PIECES



Complementary item:

960062 sigillante di tenuta - *sealant*

Technical information:

Catena semplice [chiusa] - 20 maglie
Bush chain simplex [closed] - 20 links

Kit catena distribuzione Timing chain kit

Vetture e veicoli commerciali leggeri.
Passenger cars and light commercial vehicles

Adatto a **FIAT**

Suitable for **FIAT**

3 PEZZI - 3 PIECES



384060M

Cross Ref:

9464474289, 9400849229 [FIAT]

Suitable for:

SCUDO / ULYSSE [Euro 4/5/6] - 2.0 / 2.2

4HW / 4HX / DW10BTED4 / RH02 / RHH / RHK / RHM / RHR
RHW / RHX / RHZ

Components:

x1 catena - chain
x1 tenditore - tensioner
x1 pattini/guide - guides

Technical information:

Catena semplice [chiusa] - 40 maglie
Bush chain simplex [closed] - 40 links

6 PEZZI - 6 PIECES



384193M

Cross Ref:

55225494, 55258509 [FIAT]

Suitable for:

500 / 500L / PANDA / PUNTO - 0.9

199 B6.000 / 312 A2.000 / 312 A4.000 / 312 A5.000

Components:

x1 catena - chain
x1 tenditore - tensioner
x2 pattini/guide - guides
x1 ingranaggi - gears
x1 viti - screws

Technical information:

Catena semplice [chiusa] - 142 maglie
Bush chain simplex [closed] - 142 links

Suitable for **FIAT**

Adatto a **FIAT**

385723M

Cross Ref:

71742008 [FIAT]

Suitable for:

FIAT - 1.3 / 1.5 / 1.6

M13A / M15A / M16A

Components:

- x1 catena - chain
- x1 tenditore - tensioner
- x2 pattini/guide - guides
- x1 ingranaggi - gears
- x1 paraolio - oil seal

6 PEZZI - 6 PIECES



Technical information:

Catena dentata [chiusa] - 162 maglie
Tooth chain [closed] - 162 links

387160M

Cross Ref:

6000620371 [FIAT]

Suitable for:

FIAT TALENTO - 1.6

R9M 402 / R9M 404 / R9M 408 / R9M 409 / R9M 413
R9M 414 / R9M 415 / R9M 450 / R9M 452 / OM 622.951

Components:

- x2 catena - chain
- x1 tenditore - tensioner
- x2 pattini/guide - guides
- x3 ingranaggi - gears
- x1 paraolio - oil seal

9 PEZZI - 9 PIECES



Technical information:

Catena semplice [chiusa] - 106 maglie
Bush Chain simplex, closed, 106 links

Kit catena distribuzione Timing chain kit

Vetture e veicoli commerciali leggeri.
Passenger cars and light commercial vehicles

Adatto a **FIAT**

Suitable for **FIAT**

2 PEZZI - 2 PIECES



902700M

Cross Ref:

965937118,9675827980 [FIAT]

Suitable for:

DUCATO - 2.2

4HG / 4HH / 4HJ / 4HU / 4HV

Components:

x1 catena - chain

x1 tenditore - tensioner

Technical information:

Catena semplice [chiusa] - 74 maglie

Bush chain simplex [closed] - 74 links

4 PEZZI - 4 PIECES



946411

Cross Ref:

504013619 [FIAT]

Suitable for:

DUCATO [Euro 1/2/3/4/5] - 2.3

F1AE0481C / F1AE0481D / F1AE0481N / F1AE0481T
F1AE3481D / F1AE3481E / F1AE3481G / FIAGL4111 / FIAGL4112
FIAGL4113 / FIAGL411A / FIAGL411B / FIAGL411C / FIAGL411D

Components:

x1 catena - chain

x1 tenditore - tensioner

x2 ingranaggi - gears

Technical information:

Catena semplice [chiusa] - 21 maglie

Bush chain simplex [closed] - 21 links

Suitable for **FORD**

Adatto a **FORD**

380036M

Cross Ref:

1198056 [FORD]

Suitable for:

FORD S-MAX / FOCUS - 1.8

BHDA / BHDB / BHPA / C9DA / C9DB / C9DC / FFBA
FFDA / FFWA / F9DA / F9DB / HCPA / HCPB / KHBA
KKDA / KKDB / P7PA / P7PB / P9PA / P9PB / P9PC
P9PD / QYBA / QYWA / RTN / RTP / RTQ / RWPA
RWPC / RWPB / RWPE / RWPF / R2PA / R3PA

Components:

x2 catena - chain
x1 tenditore - tensioner
x1 pattini/guide - guides
x2 ingranaggi - gears
x1 paraolio - oil seal
x2 guarnizioni - gasket

9 PEZZI - 9 PIECES



Technical information:

Catena semplice [chiusa] - 84 maglie
Bush Chain simplex [closed] - 84 links

380041M

Cross Ref:

1704089 [FORD]

Suitable for:

FORD TRANSIT - 2.4

FXFA / H9FB / H9FD / JXFA / JXFC / PHFA / PHFC

Components:

x1 catena - chain
x1 tenditore - tensioner
x4 pattini/guide - guides

6 PEZZI - 6 PIECES



Technical information:

Catena semplice [chiusa] - 132 maglie
Bush Chain simplex [closed] - 132 links

Kit catena distribuzione Timing chain kit

Vetture e veicoli commerciali leggeri.
Passenger cars and light commercial vehicles

Adatto a **FORD**

Suitable for **FORD**

6 PEZZI - 6 PIECES



Complementary item:

960062 sigillante di tenuta - sealant

Technical information:

Catena semplice [chiusa] - 132 maglie
Bush chain simplex [closed] - 132 links

381607M

Cross Ref:

1704089, 1704066, 1704049 [FORD]

Suitable for:

TRANSIT / RANGER - 2.2 / 2.4

JXFA / JXFC / H9FB / H9FD / PHFA / PHFC / CY24 / CYR5
USR6 / CV24 / CVR5 / UYR6 / DRR5

Components:

x1 catena - chain
x1 tenditore - tensioner
x4 pattini/guide - guides

5 PEZZI - 5 PIECES



Technical information:

Catena semplice [chiusa] - 122 maglie
Bush chain simplex [closed] - 122 links

381614M

Cross Ref:

1704087, 1704067, 1372438 [FORD]

Suitable for:

TRANSIT / TOURNEO - 2.2 / 2.4

DRFF / DRF4 / DRFG / CYF4 / CYFF / CVFF / P8FB / P8FA
QVFA / QWFA / PGFB / UHFC / UHFB / UHFA / PGFA / SRFE
SRFD / SRFC / SFRB / SRFA / JXFC / JXFA / H9FD / H9FB
PHFC / PHFA

Components:

x1 catena - chain
x1 tenditore - tensioner
x3 pattini/guide - guides

Suitable for **FORD**

Adatto a **FORD**

383320M

Cross Ref:

6C1Q-6268-BB [FORD]

Suitable for:

TRANSIT / TOURNEO - 2.2

CVF5 / CVFF / CY14 / CYF4 / CYF5 / CYFA / CYFB / CYFC
CYFD / CYFF / CYFG / DRF4 / DRF5 / DRFA / DRFB / DRFC
DRFD / DRFE / DRFF / DRFG / P8FA / P8FB / PGFA / PGFB
QVFA / QVFA / SRFA / SRFB / SRFC / SFRD / SRFE / UHFA
UHFB / UHFC

Components:

- x1 catena - chain
- x1 tenditore - tensioner
- x3 pattini/guide - guides
- x3 ingranaggi - gears
- x1 guarnizioni - gasket
- x1 paraolio - oil seal

383390M

Cross Ref:

1102609, 1253958, 1221119 [FORD]

Suitable for:

TRANSIT / MONDEO - 2.0 / 2.2 / 2.4

ABFA / D2FA / D2FB / D2FE / D3FA / D4FA / D5BA / D6BA
DOFA / F3FA / F4FA / F1FA / FMBA / H9FA / HJBA / HJBB
HJBC / N7BA / QJBA / QJBB / QJBC / QJBD / SDBA / SWFA

Components:

- x1 catena - chain
- x1 tenditore - tensioner
- x5 pattini/guide - guides
- x4 ingranaggi - gears
- x1 guarnizioni - gasket
- x1 paraolio - oil seal

10 PEZZI - 10 PIECES



Complementary item:

960062 sigillante di tenuta - sealant

Technical information:

Catena semplice [chiusa] - 122 maglie
Bush chain simplex [closed] - 122 links

13 PEZZI - 13 PIECES



Complementary item:

960062 sigillante di tenuta - sealant

Technical information:

Catena duplex [chiusa] - 132 maglie
Bush chain duplex [closed] - 132 links

Kit catena distribuzione Timing chain kit

Vetture e veicoli commerciali leggeri.
Passenger cars and light commercial vehicles

Adatto a **FORD**

Suitable for **FORD**

16 PEZZI - 16 PIECES



Complementary item:

960062 sigillante di tenuta - sealant

Technical information:

Catena semplice [chiusa] - 20 maglie
Bush chain simplex [closed] - 20 links

383580M

Cross Ref:

1231280, 1231282 [FORD]

Suitable for:

FOCUS / FIESTA / C-MAX - 1.6

G8DA / G8DB / G8DC / G8DD / G8DE / G8DF / GPDA / GPDB
GPDC / HHDA / HHDB / HHJA / HHJB / HHJC / HHJD / HHJE
HHJF / HXDA / HXDB / MTD / SIDA / UBJA

Components:

x1 catena - chain
x1 tenditore - tensioner
x13 guarnizioni - gasket
x1 paraolio - oil seal

3 PEZZI - 3 PIECES



Technical information:

Catena semplice [chiusa] - 40 maglie
Bush chain simplex [closed] - 40 links

384060M

Cross Ref:

1231282, 1231971 [FORD]

Suitable for:

MONDEO / KUGA / FOCUS / GALAXY / C-MAX / S-MAX
[Euro 4/5/6] - 2.0

AZBA / AZBC / AZWA / AZWC / G6DA / G6DB / G6DC / G6DD
G6DE / G6DF / G6DG / IXDA / KLBA / KLWA / LPBA / QXBA
QXBB / QXWA / QXWB / QXWC / TXBA / TXBB / TXDA
TXDB / TXWA / TYBA / TYDA / TIWA / UFBA / UFBB / UFDA
UFDB / UFMA / UFWA / UKBA / UKDA / UKDB / UKWA

Components:

x1 catena - chain
x1 tenditore - tensioner
x1 pattini/guide - guides

Suitable for **FORD**

Adatto a **FORD**

384120M

Cross Ref:

1704089, 1372841, 6C1Q-6268-BB [FORD]

Suitable for:

TRANSIT [Euro 4/5] - 2.4

FXFA / H9FB / H9FD / JXFA / JXFC / PHFA / PHFC / SWFA

Components:

- x1 catena - chain
- x1 tenditore - tensioner
- x4 pattini/guide - guides
- x4 ingranaggi - gears
- x1 guarnizioni - gasket
- x1 paraolio - oil seal

12 PEZZI - 12 PIECES



Complementary item:

960062 sigillante di tenuta - sealant

Technical information:

Catena semplice [chiusa] - 132 maglie
Bush chain simplex [closed] - 132 links

384184M

Cross Ref:

1704089 [FORD]

Suitable for:

TRANSIT / RANGER - 2.2

CV24 / CVR5 / CVRA / CVRB / CVRC / CY24 / CYR5 / CYRA
CYRB / CYRC / DRR5 / DRRR / DRRB / DRRC / UHR5 / USF6
USR6 / USRA / USRB / UYR6

Components:

- x1 catena - chain
- x1 tenditore - tensioner
- x4 pattini/guide - guides
- x4 ingranaggi - gears
- x1 guarnizioni - gasket
- x1 paraolio - oil seal

12 PEZZI - 12 PIECES



Complementary item:

960062 sigillante di tenuta - sealant

Technical information:

Catena semplice [chiusa] - 132 maglie
Bush chain simplex [closed] - 132 links

Kit catena distribuzione Timing chain kit

Vetture e veicoli commerciali leggeri.
Passenger cars and light commercial vehicles

Adatto a **FORD**

Suitable for **FORD**

12 PEZZI - 12 PIECES



384960M

Cross Ref:

1102609 [FORD]

Suitable for:

FORD TRANSIT - 2.4

DOFA / D4FA

Components:

x1 catena - chain

x2 tenditore - tensioner

x5 pattini/guide - guides

x4 ingranaggi - gears

Technical information:

Catena duplex [chiusa] - 132 maglie

Bush Chain duplex [closed] - 132 links

2 PEZZI - 2 PIECES



389746M

Cross Ref:

1448169 [FORD]

Suitable for:

FOCUS / FIESTA / C-MAX - 1.6

G8DA / G8DB / G8DC / G8DD / G8DE / G8DF / GPDA / GPDB
GPDC / HHDA / HHDB / HHJA / HHJB / HHJC / HHJD / HHJE
HHJF / HXDA / HXDB / MTD / SIDA / UBJA

Components:

x1 catena - chain

x1 tenditore - tensioner

Technical information:

Catena semplice [chiusa] - 20 maglie

Bush chain simplex [closed] - 20 links

Suitable for **FORD**

Adatto a **FORD**

902700M

Cross Ref:

1235939 [FORD]

Suitable for:

TRANSIT / RANGER / MONDEO / TOURNEO
2.0 / 2.2 / 2.4

ABFA / CV24 / CVF5 / CVFF / CVR5 / CVRA / CVRB / CVRC
CVRB / CVRC / CY14 / CY24 / CYF4 / CYF5 / CYFA / CYFB
CYFC / CYFD / CYFF / CYFG / CYR5 / CYRA / CYRB / CYRC
D2FA / D2FB / D2FE / D3FA / D4FA / D5BA / D6BA / DOFA
DRF4 / DRF5 / DRFA / DRFB / DRFC / DRFD / DRFE / DRFF
DRFG / DRR5 / DRRR / DRRB / DRRC / F3FA / F4FA / FIFA
FMBA / FXFA / H9FA / H9FB / H9FD / HJBA / HJBB /
JBCJXFA JXFC / N7BA / N7BB / P8FA / P8FB / PGFA PGFB /
PHFA

Components:

x1 catena - chain
x1 tenditore - tensioner

2 PEZZI - 2 PIECES



Technical information:

Catena semplice [chiusa] - 74 maglie
Bush chain simplex [closed] - 74 links

Kit catena distribuzione Timing chain kit

Vetture e veicoli commerciali leggeri.
Passenger cars and light commercial vehicles

Adatto a **HYUNDAI - KIA**

Suitable for **HYUNDAI - KIA**

13 PEZZI - 13 PIECES



384140M

Cross Ref:

243512A001, 243512A000, 243614A000, 243612A000
243612A001 [HYUNDAI/KIA]

Suitable for:

i20 / i30 / i40 / TUCSON / CEE'D / RIO / SPORTAGE
1.1 / 1.5 / 1.6 / 1.7

D3EA / D3FA / D4FA / D4FB / D4FC / D4FD

Components:

x2 catena - chain
x2 tenditore - tensioner
x5 pattini/guide - guides
x3 ingranaggi - gears
x1 viti - screws

Technical information:

Catena semplice [chiusa] - 76/84 maglie
Bush chain simplex [closed] - 76/84 links

14 PEZZI - 14 PIECES



384194M

Cross Ref:

233514A020, 233514A600, 233514A700, 243514A020
243612F000, 243614A020 [HYUNDAI/KIA]

Suitable for:

H100 / H350 / H1 / SORENTO - 2.5

D4CB / D4CB-W

Components:

x3 catena - chain
x3 tenditore - tensioner
x7 pattini/guide - guides
x1 paraolio - oil seal

Complementary item:

960062 sigillante di tenuta - sealant

Technical information:

Catena semplice [chiusa] - 80/90/98 maglie
Bush chain simplex [closed] - 80/90/98 links

Suitable for **HYUNDAI - KIA**

Adatto a **HYUNDAI - KIA**

385135M

Cross Ref:

24351-2F000 [HYUNDAI / KIA]

Suitable for:

HYUNDAI GRAND SANTA FE - 2.0 / 2.2

D4HA / D4HB

Components:

x2 catena - chain
x2 tenditore - tensioner
x4 pattini/guide - guides
x2 ingranaggi - gears

10 PEZZI - 10 PIECES



Technical information:

Catena semplice [chiusa] - 72/90 maglie
Bush Chain simplex [closed] - 72/90 links

385385M

Cross Ref:

24351-2A001 [HYUNDAI / KIA]

Suitable for:

HYUNDAI ACCENT II - 1.1 / 1.4 / 1.5 / 1.6 / 1.7

D3EA / D3FA / D4FA / D4FB / D4FB-L / D4FC / D4FD

Components:

x2 catena - chain
x2 tenditore - tensioner
x5 pattini/guide - guides
x3 ingranaggi - gears
x1 paraolio - oil seal
x2 guarnizioni - gasket

15 PEZZI - 15 PIECES



Technical information:

Catena semplice [chiusa] - 76/84 maglie
Bush Chain simplex [closed] - 76/84 links

Kit catena distribuzione Timing chain kit

Vetture e veicoli commerciali leggeri.
Passenger cars and light commercial vehicles

Adatto a **IVECO**

Suitable for **IVECO**

8 PEZZI - 8 PIECES



382830M

Cross Ref:

5802335733, 5801514998, 5802009618 [IVECO]

Suitable for:

DAILY [Euro 1/2/3/4] - 3.0

FICE0481A / FICE0481B / FICE0481E / FICE0481F
FICE0481H / FICE0481L / FICE0481P / FICE0441A
FICFA401A / FICFA401B / FICFA401C / FICFA401D

Components:

x1 catena - chain
x2 tenditore - tensioner
x2 pattini/guide - guides
x3 ingranaggi - gears

Technical information:

Catena semplice [chiusa] - 61 maglie
Bush chain simplex [closed] - 61 links

8 PEZZI - 8 PIECES



382835M

Cross Ref:

5801628694, 5802009617 [IVECO]

Suitable for:

DAILY [Euro 5] - 3.0

FICE0441A / FICE0481A / FICE0481B / FICE0481E
FICE0481F / FICE0481H / FICE0481L / FICE3481B
FICE3481C / FICE3481D / FICE3481J / FICE3481K
FICE3481L / FICFL411E / FICFL411F / FICFL411G / FICFL411H
FICFL411J / FICFL411W / FICGL411A / FICGL411B / FICGL411C

Components:

x1 catena - chain
x2 tenditore - tensioner
x2 pattini/guide - guides
x3 ingranaggi - gears

Technical information:

Catena semplice [chiusa] - 60 maglie
Bush chain simplex [closed] - 60 links

Suitable for **IVECO**

Adatto a **IVECO**

382980M

Cross Ref:

504091968 [IVECO]

Suitable for:

DAILY [Euro 1/2/3/4] - 3.0

FICE0441A / FICFA401A / FICFA401C / FICFA401D
FICE0481A / FICE0481B / FICE0481E / FICE0481F
FICE0481H / FICE0481L / FICE0481P

Components:

x1 catena - chain
x2 pattini/guide - guides
x2 ingranaggi - gears

5 PEZZI - 5 PIECES



Technical information:

Catena duplex [chiusa] - 42 maglie
Bush chain duplex [closed] - 42 links

382995M

Cross Ref:

5802009660 [IVECO]

Suitable for:

DAILY [Euro 5] - 3.0

FICE3481L / FICFA401A / FICFA401C / FICFA401D / FICFL4116
FICFL411C / FICFL4117 / FICFL411W / FICGL411B / FICE3481J
FICE3481D / FICE3481C / FICE3481K / FICFL411F / FICFL411H

Components:

x1 catena - chain
x2 pattini/guide - guides
x2 ingranaggi - gears

5 PEZZI - 5 PIECES



Technical information:

Catena duplex [chiusa] - 41 maglie
Bush chain duplex [closed] - 41 links

Kit catena distribuzione Timing chain kit

Vetture e veicoli commerciali leggeri.
Passenger cars and light commercial vehicles

Adatto a **IVECO**

Suitable for **IVECO**

18 PEZZI - 18 PIECES



Technical information:

Catena semplice e duplex [chiusa] - 61/42 maglie
Bush chain simplex and duplex [closed] - 61/42 links

18 PEZZI - 18 PIECES



Technical information:

Catena duplex [chiusa] - 41/60 maglie
Bush chain duplex [closed] - 41/60 links

383300

Cross Ref:

5802335733, 5801375562, 504084527, 504084528
5802009661, 5802009618 [IVECO]

Suitable for:

DAILY [Euro 3/4] - 3.0

FICE0481A / FICE0481B / FICE0481E / FICE0481F
FICE0481H / FICE0481L / FICFA401A / FICFA401B / FICFL411E
FICFL411F / FICFL411G / FICFL411H / FICFL411J / FICFL411W
FICGL411A / FICGL411B / FICGL411C

Components:

x1 kit catena - timing kit **382830**
x1 kit catena - timing kit **382980**
x2 pattini/guide - guides
x2 guarnizioni - gasket
x1 paraolio - oil seal
x1 viti - screws

383500

Cross Ref:

5801628694, 504294672, 5802009617 [IVECO]

Suitable for:

DAILY [Euro 5] - 3.0

FICE3481L / FICFA401A / FICFA401C / FICFA401D / FICFL4116
FICFL411C / FICFL4117 / FICFL411W / FICGL411B / FICE3481J
FICE3481D / FICE3481C / FICE3481K / FICFL411F / FICFL411H

Components:

x1 kit catena - timing kit **382995**
x1 kit catena - timing kit **382835**
x2 pattini/guide - guides
x2 guarnizioni - gasket
x1 paraolio - oil seal
x1 viti - screws

Suitable for **IVECO**

Adatto a **IVECO**

383503M

Cross Ref:

5802122595 [FIAT]

Suitable for:

DAILY [Euro 5/6] - 3.0

FICE3481L / FICFA401A / FICFA401C / FICFA401D
FICE3481B / FICE3481J / FICFL411E / FICFL411J / FICFL411V
FICGL411A / FICFL411G / FICFL4115 / FICFL4116 / FICFL4117
FICFL411W

Components:

x2 pattini/guide - guides
x1 viti - screws

3 PEZZI - 3 PIECES



Technical information:

946411

Cross Ref:

504068388 [IVECO]

Suitable for:

DAILY [Euro 1/2/3/4/5] - 2.3

F1AE0481A / F1AE0481B / F1AE0481F / F1AE0481G
F1AE0481H / F1AE0481M / F1AE0481R / F1AE0481U
F1AE0481V / F1AE3481A / F1AE3481B / F1AE3481C / F1AFL411A
F1AFL411B / F1AFL411C / F1AFL411G / F1AFL411H / F1AFL411J

Components:

x1 catena - chain
x1 tenditore - tensioner
x2 ingranaggi - gears

4 PEZZI - 4 PIECES



Technical information:

Catena semplice [chiusa] - 21 maglie
Bush chain simplex [closed] - 21 links

Kit catena distribuzione Timing chain kit

Vetture e veicoli commerciali leggeri.
Passenger cars and light commercial vehicles

Adatto a **LAND ROVER**

Suitable for **LAND ROVER**

9 PEZZI - 9 PIECES



381980M

Cross Ref:

LR132676 [LAND ROVER]

Suitable for:

LAND ROVER DEFENDER / DISCOVERY - 2.0

204DTA / 204DTD

Components:

x2 catena - chain
x2 tenditore - tensioner
x5 pattini/guide - guides

Technical information:

Catena semplice [chiusa] - 82/90 maglie
Bush Chain simplex [closed] - 82/90 links

12 PEZZI - 12 PIECES



384120M

Cross Ref:

LR004457, LR023524 [LAND ROVER]

Suitable for:

DEFENDER [Euro 4/5] - 2.4

DT244

Components:

x1 catena - chain
x1 tenditore - tensioner
x4 pattini/guide - guides
x4 ingranaggi - gears
x1 guarnizioni - gasket
x1 paraolio - oil seal

Complementary item:

960062 sigillante di tenuta - sealant

Technical information:

Catena semplice [chiusa] - 132 maglie
Bush chain simplex [closed] - 132 links

Suitable for **LAND ROVER**

Adatto a **LAND ROVER**

384660M

Cross Ref:

LR132676 [LAND ROVER]

Suitable for:

LAND ROVER DEFENDER - 2.0

204DTA / 204DTD

Components:

x2 catena - chain
x2 tenditore - tensioner
x5 pattini/guide - guides
x4 ingranaggi - gears
x1 paraolio - oil seal
x4 guarnizioni - gasket

18 PEZZI - 18 PIECES



Technical information:

Catena semplice [chiusa] - 82/90 maglie
Bush Chain simplex [closed] - 82/90 links

385715M

Cross Ref:

1316113 [LAND ROVER]

Suitable for:

DISCOVERY / RANGE ROVER VELAR - 2.7 / 3.0

276DT / 306DT / 30DDTX

Components:

x1 catena - chain
x1 tenditore - tensioner
x2 viti - screws

4 PEZZI - 4 PIECES



Technical information:

Catena semplice [chiusa] - 44 maglie
Bush chain simplex [closed] - 44 links

Kit catena distribuzione Timing chain kit

Vetture e veicoli commerciali leggeri.
Passenger cars and light commercial vehicles

Adatto a **LAND ROVER**

Suitable for **LAND ROVER**

2 PEZZI - 2 PIECES



902700M

Cross Ref:

LR004405S1, LR004406S1, LR019664S1 [LAND ROVER]

Suitable for:

DEFENDER - 2.2 / 2.4

244DT / DT224 / DT244

Components:

x1 catena - chain

x1 tenditore - tensioner

Technical information:

Catena semplice [chiusa] - 74 maglie

Bush chain simplex [closed] - 74 links

Suitable for **MERCEDES**

Adatto a **MERCEDES**

380002M

Cross Ref:

A0039977594, A5080209AA [VW]

Suitable for:

CLASSE C / E / G / M / S / V / SPRINTER / VITO
2.1 / 2.7 / 3.0 / 3.2

OM 611.960 / OM 611.961 / OM 611.962 / OM 611.980
OM 611.981 / OM 611.987 / OM 611A / OM 611LA / OM 612.961
OM 612.962 / OM 612.963 / OM 612.965 / OM 612.966
OM 612.967 / OM 612.981 / OM 612.990 / OM 613.960
OM 613.961 / OM 646.811 / OM 646.812 / OM 646.820
OM 646.821 / OM 646.951 / OM 646.961 / OM 646.962
OM 646.963 / OM 646.966 / OM 646.980 / OM 646.981

Components:

x1 catena - chain
x1 tenditore - tensioner
x3 pattini/guide - guides
x2 viti - screws



7 PEZZI - 7 PIECES

Technical information:

Catena duplex [chiusa] - 110 maglie
Bush chain duplex [closed] - 110 links

380022M

Cross Ref:

A0009936276 [MB]

Suitable for:

MB CLASSE A/B/C/E SPRINTER / VITO - 2.2

OM 651.901 / OM 651.911 / OM 651.912 / OM 651.913
OM 651.916 / OM 651.921 / OM 651.924 / OM 651.925
OM 651.930 / OM 651.940 / OM 651.950 / OM 651.955
OM 651.956 / OM 651.957 / OM 651.960 / OM 651.961
OM 651.980

Components:

x1 catena - chain
x1 tenditore - tensioner
x2 pattini/guide - guides
x2 ingranaggi - gears
x1 paraolio - oil seal
x2 guarnizioni - gasket



9 PEZZI - 9 PIECES

Technical information:

Catena semplice [aperta] - 96 maglie
Bush Chain simplex [open] - 96 links

Kit catena distribuzione Timing chain kit

Vetture e veicoli commerciali leggeri.
Passenger cars and light commercial vehicles

Adatto a **MERCEDES**

Suitable for **MERCEDES**

9 PEZZI - 9 PIECES



Technical information:

Catena semplice [aperta] - 96 maglie
Bush Chain simplex [open] - 96 links

380023M

Cross Ref:

A0009936276 [MB]

Suitable for:

MB CLASSE A/B/C - 2.2

OM 651.901 / OM 651.911 / OM 651.912 / OM 651.913
OM 651.916 / OM 651.921 / OM 651.924 / OM 651.925
OM 651.930 / OM 651.940 / OM 651.950 / OM 651.955
OM 651.956 / OM 651.957 / OM 651.960 / OM 651.961
OM 651.980

Components:

x1 catena - chain
x1 tenditore - tensioner
x2 pattini/guide - guides
x2 ingranaggi - gears
x1 paraolio - oil seal
x2 guarnizioni - gasket

6 PEZZI - 6 PIECES



Technical information:

Catena semplice [chiusa] - 110 maglie
Bush chain simplex [closed] - 110 links

383200M

Cross Ref:

1609970494, 1609970494S5, 1600500211 [MERCEDES]

Suitable for:

SMART CABRIO / CITY-COUPÉ / FORTWO / ROADSTER
0.6 / 0.7

M 160.910 / M 160.920 / M 160.921 / M 160.922 / M 160.923
M 160 E6AL B03 / M 160 E6AL B04

Components:

x1 catena - chain
x1 tenditore - tensioner
x2 pattini/guide - guides
x2 ingranaggi - gears

Suitable for **MERCEDES**

Adatto a **MERCEDES**

383202M

Cross Ref:

1609970294, 1609970494, 1609970594,
A1600500369 [MERCEDES]

Suitable for:

SMART CABRIO / CITY-COUPE / FORTWO / ROADSTER
0.6 / 0.7

M 160.910 / M 160.920 / M 160.921 / M 160.922 / M 160.923
M 160 E6AL B03 / M 160 E6AL B04 / M 160 E6AL B05

Components:

- x1 catena - chain
- x1 tenditore - tensioner
- x3 pattini/guide - guides
- x4 ingranaggi - gears
- x2 paraolio - oil seal
- x1 spruzzatore olio - oil spray pipe

13 PEZZI - 13 PIECES



Technical information:

Catena semplice [chiusa] - 54/110 maglie
Bush chain simplex [closed] - 54/110 links

383251M

Cross Ref:

6609970094, A0003953V00100000 [MERCEDES]

Suitable for:

SMART CABRIO / CITY-COUPE / FORTWO - 0.8

OM 660 DE 8LA / OM 660.940 / OM 660.950 / OM 660.951

Components:

- x1 catena - chain
- x1 tenditore - tensioner
- x2 pattini/guide - guides
- x2 ingranaggi - gears
- x1 paraolio - oil seal
- x1 viti - screws
- x1 ugello olio - oil feed pipe

9 PEZZI - 9 PIECES



Complementary item:

960062 sigillante di tenuta - sealant

Technical information:

Catena semplice [chiusa] - 100 maglie
Bush chain simplex [closed] - 100 links

Kit catena distribuzione Timing chain kit

Vetture e veicoli commerciali leggeri.
Passenger cars and light commercial vehicles

Adatto a **MERCEDES**

Suitable for **MERCEDES**

9 PEZZI - 9 PIECES



Technical information:

Catena semplice [chiusa] - 96 maglie
Bush Chain simplex [closed] - 96 links

384800M

Cross Ref:

A0009933502 [MB]

Suitable for:

MB CLASSE A/B/C - 1.8 / 2.2

OM 651.901 / OM 651.911 / OM 651.912 / OM 651.921
OM 651.924 / OM 651.925 / OM 651.930 / OM 651.940
OM 651.950 / OM 651.955 / OM 651.957

Components:

x1 catena - chain
x1 tenditore - tensioner
x2 pattini/guide - guides
x2 ingranaggi - gears
x1 paraolio - oil seal
x2 guarnizioni - gasket

4 PEZZI - 4 PIECES



Technical information:

Catena semplice [chiusa] - 96 maglie
Bush Chain simplex [closed] - 96 links

385305M

Cross Ref:

A0009933502 [MB]

Suitable for:

MB CLA COUPE' - 1.8 / 2.2

OM 651.901 / OM 651.912 / OM 651.921 / OM 651.924
OM 651.925 / OM 651.930 / OM 651.940 / OM 651.950
OM 651.955 / OM 651.957

Components:

x1 catena - chain
x1 tenditore - tensioner
x2 pattini/guide - guides

Suitable for **MERCEDES**

Adatto a **MERCEDES**

385748M

Cross Ref:

A0009934676, A0009936176, A0009933502
A0009936276, A0009938276 [MERCEDES]

Suitable for:

SPRINTER / VITO / CLASSE A / B / C / E / S
CLA / CLS GLA / GLC / GLK - 1.8 / 2.2

OM 651.901 / OM 651.911 / OM 651.912 / OM 651.913
OM 651.921 / OM 651.924 / OM 651.925 / OM 651.930
OM 651.940 / OM 651.950 / OM 651.955 / OM 651.956
OM 651.957 / OM 651.958

Components:

x1 catena - chain
x1 tenditore - tensioner
x2 pattini/guide - guides
x2 ingranaggi - gears

6 PEZZI - 6 PIECES



Technical information:

Catena semplice [aperta] - 96 maglie
Bush Chain simplex [open] - 96 links

385755M

Cross Ref:

A0009934676, A0009936176
A0009936276 [MERCEDES]

Suitable for:

SPRINTER / VITO / CLASSE A / B / C / E
CLA / CLS / GLA / GLC / GLE / GLK - 1.8 / 2.2

OM 651.901 / OM 651.911 / OM 651.912 / OM 651.913
OM 651.916 / OM 651.921 / OM 651.924 / OM 651.925
OM 651.930 / OM 651.940 / OM 651.950 / OM 651.955
OM 651.956 / OM 651.957 / OM 651.958 / OM 651.960
OM 651.961 / OM 651.980

Components:

x1 catena - chain
x1 tenditore - tensioner
x2 pattini/guide - guides
x2 ingranaggi - gears

6 PEZZI - 6 PIECES



Technical information:

Catena semplice [chiusa] - 96 maglie
Bush chain simplex [closed] - 96 links

Kit catena distribuzione Timing chain kit

Vetture e veicoli commerciali leggeri.
Passenger cars and light commercial vehicles

Adatto a **MERCEDES**

Suitable for **MERCEDES**

5 PEZZI - 5 PIECES



Technical information:

Catena duplex [chiusa] - 126 maglie
Bush chain duplex [closed] - 126 links

385769M

Cross Ref:

A0029973394S1, A0039972094S1
A39974294 [MERCEDES]

Suitable for:

124 / 190 / CLASSE E / G / SPRINTER / VITO / VARIO
2.0 / 2.3 / 2.5 / 2.9 / 3.0 / 3.5

OM 601.911 / OM 601.912 / OM 601.913 / OM 601.940
OM 601.941 / OM 601.942 / OM 601.943 / OM 601.970
OM 602.911 / OM 602.912 / OM 602.930 / OM 602.931
OM 602.939 / OM 602.940 / OM 602.942 / OM 602.961
OM 602.962 / OM 602.980 / OM 602.982 / OM 602.983
OM 602.984 / OM 602.985 / OM 603.912 / OM 603.913
OM 603.931 / OM 603.960 / OM 603.963 / OM 603.971

Components:

x1 catena - chain
x1 tenditore - tensioner
x3 pattini/guide - guides

Suitable for **NISSAN**

Adatto a **NISSAN**

380003M

Cross Ref:

130C17833R [NISSAN] (CROSS RENAULT)

Suitable for:

NAVARA / NV400 - 2.3 / 3.0

M9T 670 / M9T 672 / M9T 676 / M9T 678 / M9T 680
M9T 686 / M9T 690 / M9T 692 / M9T 694 / M9T 696
M9T 698 M9T 702 / M9T 870 / M9T 880 / M9T 896
YS23DDT / YS23DDTT

Components:

x1 catena - chain
x1 tenditore - tensioner
x2 pattini/guide - guides
x2 ingranaggi - gears
x1 paraolio - oil seal
x1 strumento di montaggio - installation tool



8 PEZZI - 8 PIECES

Technical information:

Catena semplice [chiusa] - 116 maglie
Bush chain simplex [closed] - 116 links

380038M

Cross Ref:

13028AD212, 13028AW410, 13028AD211
13028AD202 [NISSAN]

Suitable for:

NAVARA / NP300 / PATHFINDER - 2.5

YD25DDTi / YD25K3LD-5HO / YD25K3LD-5LO
YD25K3LD-5MI

Components:

x2 catena - chain
x2 tenditore - tensioner
x7 pattini/guide - guides
x4 ingranaggi - gears



15 PEZZI - 15 PIECES

Complementary item:

960062 sigillante di tenuta - sealant

Technical information:

Catena duplex [chiusa] - Com. Rail - 92/94 maglie
Bush chain duplex [closed]- Com. Rail - 92/94 links

Kit catena distribuzione Timing chain kit

Vetture e veicoli commerciali leggeri.
Passenger cars and light commercial vehicles

Adatto a **NISSAN**

Suitable for **NISSAN**

17 PEZZI - 17 PIECES



Complementary item:

960062 sigillante di tenuta - sealant

Technical information:

Catena duplex [chiusa] - No Com. R - 92/94 maglie
Bush chain duplex [closed] - Not Com. R - 92/94 links

380039M

Cross Ref:

13028AD212, 13028AW410, 13028AD211
13028AD202 [NISSAN]

Suitable for:

NAVARA / NP300 / PATHFINDER - 2.5

YD25DDTi / YD25K3LD-5H0 / YD25K3LD-5L0
YD25K3LD-5MI

Components:

x2 catena - chain
x2 tenditore - tensioner
x7 pattini/guide - guides
x4 ingranaggi - gears
x1 paraolio - oil seal
x1 staffa - bracket

17 PEZZI - 17 PIECES



Complementary item:

960062 sigillante di tenuta - sealant

Technical information:

Catena duplex [chiusa] - 92/94 maglie
Bush chain duplex [closed] - 92/94 links

384110M

Cross Ref:

13028AD212, 13028AW410, 13028AD211
13028EB300 [NISSAN]

Suitable for:

CABSTAR / NAVARA / NP300 / PATHFINDER - 2.5

YD25DDTi / YD25K3LD-5H0 / YD25K3LD-5L0
YD25K3LD-5MI

Components:

x2 catena - chain
x2 tenditore - tensioner
x7 pattini/guide - guides
x4 ingranaggi - gears
x1 paraolio - oil seal
x1 staffa - bracket

Suitable for **NISSAN**

Adatto a **NISSAN**

384172M

Cross Ref:

1302800Q0A, 1302800Q0E [NISSAN]

Suitable for:

PRIMASTAR / QASHQAI / X-TRAIL - 2.0

M1D / M9R 630 / M9R 692 / M9R 760 / M9R 780
M9R 782 / M9R 786 / M9R

Components:

- x1 catena - chain
- x1 tenditore - tensioner
- x2 pattini/guide - guides
- x2 ingranaggi - gears
- x6 viti - screws
- x1 strumento di montaggio - installation tool

13 PEZZI - 13 PIECES



Complementary item:

960062 sigillante di tenuta - sealant

Technical information:

Catena semplice [chiusa] - 112 maglie
Bush chain simplex [closed] - 112 links

384182M

Cross Ref:

13028-00QAA, 13028-2W200 [NISSAN]

Suitable for:

INTERSTAR / PATROL / TERRANO - 3.0

ZD30 / ZD30DD / ZD30DDT / ZD30DDTi / ZD30H HD-5
ZD30Ti

Components:

- x1 catena - chain
- x1 tenditore - tensioner
- x2 pattini/guide - guides
- x2 ingranaggi 26 denti - gears with 26 teeth
- x1 paraolio - oil seal

7 PEZZI - 7 PIECES



Technical information:

Catena semplice [chiusa] - 82 maglie
Bush chain simplex [closed] - 82 links

Kit catena distribuzione Timing chain kit

Vetture e veicoli commerciali leggeri.
Passenger cars and light commercial vehicles

Adatto a **NISSAN**

Suitable for **NISSAN**

6 PEZZI - 6 PIECES



384187M

Cross Ref:

1302800Q1D, 1351000Q0A [NISSAN]

Suitable for:

QASHQAI / X-TRAIL - 1.6

R9M 409

Components:

x1 catena - chain
x1 tenditore - tensioner
x2 pattini/guide - guides
x1 ingranaggi - gears
x1 pignone 38mm - sprocket 38mm

Technical information:

Catena semplice [chiusa] - 106 maglie
Bush chain simplex [closed] - 106 links

6 PEZZI - 6 PIECES



384210M

Cross Ref:

1302800Q0M, 1302800Q1D [NISSAN]

Suitable for:

NV300 / QASHQAI / X-TRAIL - 1.6

R9M 413 / R9M 415 / R9M 452 / R9M

Components:

x1 catena - chain
x1 tenditore - tensioner
x2 pattini/guide - guides
x1 ingranaggi - gears
x1 pignone 38mm - sprocket 38mm

Technical information:

Catena semplice [chiusa] - 106 maglie
Bush chain simplex [closed] - 106 links

Suitable for **NISSAN**

Adatto a **NISSAN**

385800M

Cross Ref:

13028AD20A [NISSAN]

Suitable for:

NISSAN ALMERA II (N16) - 2.2

YD22DDT / YD22DDTI / YD22ETI

Components:

x3 catena - chain
x2 tenditore - tensioner
x8 pattini/guide - guides
x5 ingranaggi - gears
x1 paraolio - oil seal

19 PEZZI - 19 PIECES



Technical information:

Catena semplice e duplex [chiusa] - 64/92/94 maglie
Bush Chain simplex and duplex [closed] - 64/92/94 links

385805M

Cross Ref:

13028-EB70A, 13028-EB70B [NISSAN]

Suitable for:

CABSTAR / NAVARA / NP300 / NT400 / NV350
PATHFINDER - 2.5

YD25DDTi / YD25K3LD-5H0 / YD25K3LD-5L0
YD25K3LD-5MI

Components:

x2 catena - chain
x2 tenditore - tensioner
x7 pattini/guide - guides
x4 ingranaggi - gears
x1 guarnizioni - gasket
x1 paraolio - oil seal
x1 viti - screws

18 PEZZI - 18 PIECES



Technical information:

Catena semplice e duplex [chiusa] - 94/92 maglie
Bush chain simplex and duplex [closed] - 94/92 links

Kit catena distribuzione Timing chain kit

Vetture e veicoli commerciali leggeri.
Passenger cars and light commercial vehicles

Adatto a **NISSAN**

Suitable for **NISSAN**

7 PEZZI - 7 PIECES



Complementary item:

960062 sigillante di tenuta - sealant

Technical information:

Catena semplice [chiusa] - 106 maglie
Bush chain simplex [closed] - 106 links

385811M

Cross Ref:

Suitable for:

NV300 / QASHQAI / X-TRAIL - 1.6

R9M 413 / R9M 415 / R9M 452 / R9M

Components:

x1 catena - chain

x1 tenditore - tensioner

x2 pattini/guide - guides

x2 ingranaggi - gears

x1 strumento di montaggio - installation tool

Suitable for **OPEL**

Adatto a **OPEL**

380003M

Cross Ref:

130C17833R [OPEL] (CROSS RENAULT)

Suitable for:

MOVANO - 2.3

M9T 670 / M9T672 / M9T 676 / M9T 678 / M9T 680
M9T 686 / M9T 690 / M9T 692 / M9T 694 / M9T 696
M9T 698 M9T 702 / M9T 870 / M9T 880 / M9T 896

Components:

x1 catena - chain
x1 tenditore - tensioner
x2 pattini/guide - guides
x2 ingranaggi - gears
x1 paraolio - oil seal
x1 strumento di montaggio - installation tool



8 PEZZI - 8 PIECES

Technical information:

Catena semplice [chiusa] - 116 maglie
Bush chain simplex [closed] - 116 links

380037M

Cross Ref:

55562234 [OPEL]

Suitable for:

COMBO / AGILA / ASTRA / CORSA / MERIVA
1.0 / 1.2 / 1.4

X10XE / X12XE / Z10XE / Z10XEP / Z12XE / Z12XEP / Z14XEL
Z14XEP

Components:

x1 catena - chain
x1 tenditore - tensioner
x3 pattini/guide - guides
x1 guarnizioni - gasket
x1 paraolio - oil seal
x2 viti - screws



9 PEZZI - 9 PIECES

Technical information:

Catena semplice [chiusa] - 130 maglie
Bush chain simplex [closed] - 130 links

Kit catena distribuzione Timing chain kit

Vetture e veicoli commerciali leggeri.
Passenger cars and light commercial vehicles

Adatto a **OPEL**

Suitable for **OPEL**

14 PEZZI - 14 PIECES



Technical information:

Catena semplice [chiusa] - 130 maglie
Bush Chain simplex [closed] - 130 links

380044M

Cross Ref:

55562234 [OPEL]

Suitable for:

OPEL - 1.0 / 1.4

A 10 XEP / Z 14 XEL / Z 14 XEP

Components:

x1 catena - chain
x1 tenditore - tensioner
x3 pattini/guide - guides
x3 ingranaggi - gears
x3 viti - screws
x1 tappo - cap
x1 paraolio - oil seal
x1 guarnizioni - gasket

3 PEZZI - 3 PIECES



Technical information:

Catena semplice [chiusa] - 32 maglie
Bush Chain simplex [closed] - 32 links

381960M

Cross Ref:

646139 [OPEL]

Suitable for:

OPEL ASTRA - 1.6

A 16 DTH / B 16 DTC / B 16 DTE / B 16 DTH / B 16 DTJ
B 16 DTL / B 16 DTN / B 16 DTR / B 16 DTU / D 16 DTE
D 16 DTH / D 16 DTI / D 16 DTJ / D 16 DTN / D 16 DTR

Components:

x1 catena - chain
x1 tenditore - tensioner
x1 ingranaggi - gears

Suitable for **OPEL**

Adatto a **OPEL**

383105M

Cross Ref:

46804589, 55221385 [OPEL]

Suitable for:

AGILA / ASTRA / CORSA / COMBO / MERIVA - 1.3

A13DTC / A13DTE / A13DTR / A13FD / D13A / Y13DT / Z13DT
Z13DTE / Z13FTH / Z13DTI / Z13DTJ / Z13DTR

Components:

- x1 catena - chain
- x1 tenditore - tensioner
- x2 pattini/guide - guides
- x2 ingranaggi - gears
- x1 guarnizioni - gasket
- x1 paraolio - oil seal
- x7 viti - screws
- x1 ugello olio - oil feed pipe

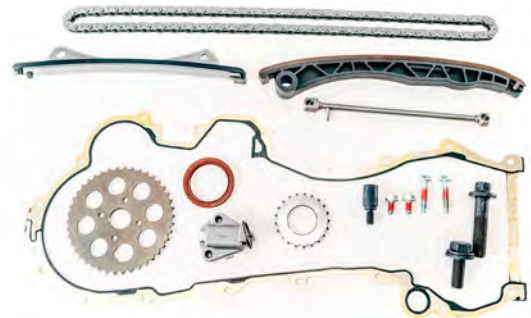

16 PEZZI - 16 PIECES

Technical information:

Catena semplice forata [chiusa] - 120 maglie
Closed simplex chain with lube-hole sleeves - 120 links

383106M

Cross Ref:

46804589, 55221385 [OPEL]

Suitable for:

AGILA / ASTRA / CORSA / COMBO / MERIVA - 1.3

A13DTC / A13DTE / A13DTR / A13FD / D13A / Y13DT / Z13DT
Z13DTE / Z13FTH / Z13DTI / Z13DTJ / Z13DTR

Components:

- x1 catena - chain
- x1 tenditore - tensioner
- x2 pattini/guide - guides
- x2 ingranaggi - gears
- x1 guarnizioni - gasket
- x1 paraolio - oil seal
- x9 viti - screws
- x1 ugello olio - oil feed pipe
- x1 flangia - flange

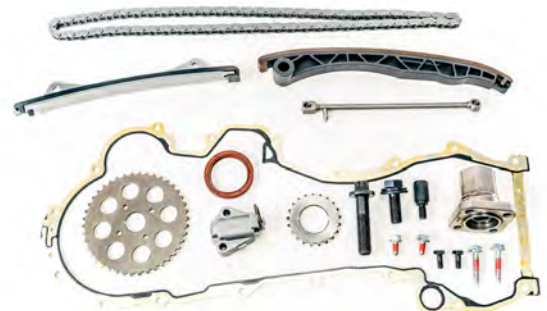

19 PEZZI - 19 PIECES

Technical information:

Catena semplice forata [chiusa] - 120 maglie
Closed simplex chain with lube-hole sleeves - 120 links

Kit catena distribuzione Timing chain kit

Vetture e veicoli commerciali leggeri.
Passenger cars and light commercial vehicles

Adatto a **OPEL**

Suitable for **OPEL**

8 PEZZI - 8 PIECES



Technical information:

Catena semplice [chiusa] - 120 maglie
Bush chain simplex [closed] - 120 links

383107

Cross Ref:

46804589, 55221385 [OPEL]

Suitable for:

COMBO / AGILA / ASTRA / CORSA / MERIVA - 1.3

A13DTC / A13DTE / A13DTR / A13FD / D13A / Y13DT / Z13DT
Z13DTE / Z13FTH / Z13DTI / Z13DTJ / Z13DTR

Components:

x1 catena - chain
x1 tenditore - tensioner
x2 pattini/guide - guides
x2 ingranaggi - gears
x1 guarnizioni - gasket
x1 paraolio - oil seal

19 PEZZI - 19 PIECES



Technical information:

Catena semplice [chiusa] - 120 maglie
Bush Chain simplex [closed] - 120 links

383116M

Cross Ref:

-

Suitable for:

OPEL EURO 6 - 1.3

B 13 DTC / B 13 DTE / B 13 DTR

Components:

x1 catena - chain
x1 tenditore - tensioner
x2 pattini/guide - guides
x2 ingranaggi - gears
x9 viti - screws
x1 paraolio - oil seal
x1 guarnizioni - gasket
x1 adattatore - adapter
x1 ugello olio - oil feed pipe

Suitable for **OPEL**

Adatto a **OPEL**

383212

Cross Ref:

55562234, 6606022, 90529570 [OPEL]

Suitable for:

COMBO / AGILA / ASTRA / CORSA / MERIVA
1.0 / 1.2 / 1.4

X10XE / X12XE / Z10XE / Z10XEP / Z12XE / Z12XEP / Z14XEL
Z14XEP

Components:

x1 catena - chain
x1 tenditore - tensioner
x3 pattini/guide - guides
x3 ingranaggi - gears
x1 guarnizioni - gasket
x1 paraolio - oil seal
x4 viti - screws
x2 rondelle - washers

16 PEZZI - 16 PIECES



Technical information:

Catena semplice [chiusa] - 130 maglie
Bush chain simplex [closed] - 130 links

383216M

Cross Ref:

93177407, 5636444 [OPEL]

Suitable for:

AGILA / ASTRA / CORSA / COMBO / MERIVA
[Euro 4/5] - 1.3

A13DTC / A13DTE / A13DTR / A13FD / D13A / Y13DT / Z13DT
Z13DTE / Z13FTH / Z13DTI / Z13DTJ / Z13DTR

Components:

x1 catena - chain
x1 tenditore - tensioner
x2 pattini/guide - guides
x2 ingranaggi - gears
x1 guarnizioni - gasket
x1 paraolio - oil seal
x1 ugello olio - oil feed pipe

9 PEZZI - 9 PIECES

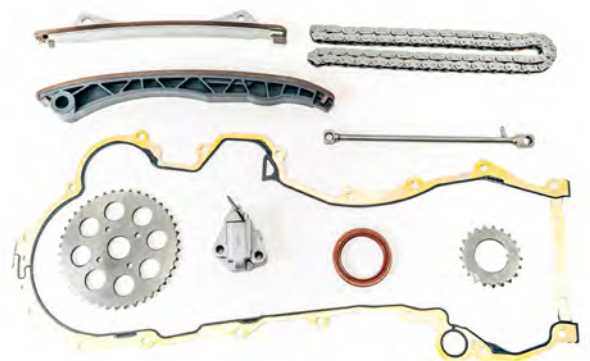

Technical information:

Catena semplice [chiusa] - 120 maglie
Bush chain simplex [closed] - 120 links

Kit catena distribuzione Timing chain kit

Vetture e veicoli commerciali leggeri.
Passenger cars and light commercial vehicles

Adatto a **OPEL**

Suitable for **OPEL**

13 PEZZI - 13 PIECES



Complementary item:

960062 sigillante di tenuta - sealant

Technical information:

Catena semplice [chiusa] - 112 maglie
Bush chain simplex [closed] - 112 links

384172M

Cross Ref:

4452569, 93161656, 93198847 [OPEL]

Suitable for:

VIVARO - 2.0

M9R 630 / M9R 692 / M9R 780 / M9R 782 / M9R 784
M9R 786 / M9R 788

Components:

x1 catena - chain
x1 tenditore - tensioner
x2 pattini/guide - guides
x2 ingranaggi - gears
x6 viti - screws
x1 strumento di montaggio - installation tool

7 PEZZI - 7 PIECES



384182M

Cross Ref:

4415559 [OPEL]

Suitable for:

MOVANO - 3.0

ZD3 200 / ZD3 202

Components:

x1 catena - chain
x1 tenditore - tensioner
x2 pattini/guide - guides
x2 ingranaggi 26 denti - gears 26 teeth
x1 paraolio - oil seal

Technical information:

Catena semplice [chiusa] - 82 maglie
Bush chain simplex [closed] - 82 links

Suitable for **OPEL**

Adatto a **OPEL**

384187M

Cross Ref:

4431143, 93161608 [OPEL]

Suitable for:

VIVARO - 1.6

R9M 408 / R9M 413 / R9M 415 / R9M 450 / R9M 452

Components:

- x1 catena - chain
- x1 tenditore - tensioner
- x2 pattini/guide - guides
- x1 ingranaggi - gears
- x1 pignone 38mm - sprocket 38mm

6 PEZZI - 6 PIECES



Technical information:

Catena semplice [chiusa] - 106 maglie
Bush chain simplex [closed] - 106 links

384210M

Cross Ref:

4423571 [OPEL]

Suitable for:

VIVARO - 1.6

R9M 408 / R9M 413 / R9M 450 / R9M 452

Components:

- x1 catena - chain
- x1 tenditore - tensioner
- x2 pattini/guide - guides
- x1 ingranaggi - gears
- x1 pignone 38mm - sprocket 38mm

6 PEZZI - 6 PIECES



Technical information:

Catena semplice [chiusa] - 106 maglie
Bush chain simplex [closed] - 106 links

Kit catena distribuzione Timing chain kit

Vetture e veicoli commerciali leggeri.
Passenger cars and light commercial vehicles

Adatto a **OPEL**

Suitable for **OPEL**

11 PEZZI - 11 PIECES

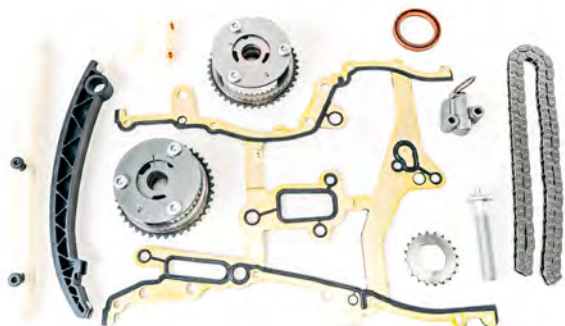

Technical information:

Catena semplice [chiusa] - 130 maglie
Bush chain simplex [closed] - 130 links

385704M

Cross Ref:

5636360, 90529570, 55562234, 637241
95522267, 55562222 [OPEL]

Suitable for:

ADAM / ASTRA / CORSA / MOKKA / MERIVA
INSIGNA / ZAFIRA - 1.2 / 1.4

A12XEL / A12XER / A14NEL / A14NET / A14XEL / A14XER
A14XFL / B12XEL / B12XER / B14NEH / B14NEJ / B14NEL
B14NET / B14XEJ / B14XEL

Components:

x1 catena - chain
x1 tenditore - tensioner
x3 pattini/guide - guides
x1 ingranaggi - gears
x1 guarnizioni - gasket
x1 paraolio - oil seal
x1 viti - screws
x2 VVT

7 PEZZI - 7 PIECES



Complementary item:

960062 sigillante di tenuta - sealant

Technical information:

Catena semplice [chiusa] - 106 maglie
Bush chain simplex [closed] - 106 links

385811M

Cross Ref:

Suitable for:

VIVARO - 1.6

R9M 408 / R9M 413 / R9M 450 / R9M 452

Components:

x1 catena - chain
x1 tenditore - tensioner
x2 pattini/guide - guides
x2 ingranaggi - gears
x1 strumento di montaggio - installation tool

Suitable for **PIAGGIO**

Adatto a **PIAGGIO**

380695

Cross Ref:

B010097, B010098, B010107, B010109 [PIAGGIO]

Suitable for:

PORTER - 1.3

DA471QLR / LDW1308

Components:

- x1 catena - chain
- x1 tenditore - tensioner
- x3 pattini/guide - guides

5 PEZZI - 5 PIECES



Technical information:

Catena semplice [chiusa] - 114 maglie

Bush chain simplex [closed] - 114 links

Adatto a **PSA - PEUGEOT/CITROEN**

Suitable for **PSA - PEUGEOT/CITROEN**

13 PEZZI - 13 PIECES



Complementary item:

960062 sigillante di tenuta - sealant

Technical information:

Catena semplice [chiusa] - 144 maglie
Bush chain simplex [closed] - 144 links

380031M

Cross Ref:

0816H9, V861831780, 98 228 271 80 [PSA]

Suitable for:

C4 / C5 / DS3 / DS4 / DS5
3008 / 5008 / 308 / 508 - 1.6

5F4 / 5FA / 5FC / 5FD / 5FE / 5FF / 5FM / 5FN / 5FR / 5FT
5FV / 5FX / 5FY / 5GF / 5GM / 5GX / 5GY / 5GZ / 5GB / 5GC
5GG / 5GQ / 5GR / 5GW / 5GX / 5GZ / EGX / GCR / GFR

Components:

x1 catena - chain
x1 tenditore - tensioner
x3 pattini/guide - guides
x2 ingranaggi - gears
x3 guarnizioni - gasket
x1 paraolio - oil seal
x2 viti - screws

37 PEZZI - 37 PIECES



Complementary item:

960062 sigillante di tenuta - sealant

Technical information:

Catena semplice [chiusa] - 138 maglie
Bush chain simplex [closed] - 138 links

380046M

Cross Ref:

0816J2, V8 618 318 80 [PSA]

Suitable for:

BERLINGO / PARTNER - 1.4 / 1.6

5FA / 5FG / 5FH / 5FK / 5FP / 5FS / 5FU / 5FW / 5FY / 5GB
5GF / 5GG / 5GL / 5GM / 5GN / 5GP / 5GQ / 5GR / 5GT / 5GV
5GX / 5GY / 8FP / 8FR / 8FS / EGX / EP3 / EP3C / EP6 / GCR
GFR / GGR

Components:

x1 catena - chain
x1 tenditore - tensioner
x3 pattini/guide - guides
x7 guarnizioni - gasket
x1 paraolio - oil seal
x24 viti - screws

Suitable for **PSA - PEUGEOT/CITROEN**

Adatto a **PSA - PEUGEOT/CITROEN**

380047M

Cross Ref:

0816H9, 98 228 271 80, V861831780 [PSA]

Suitable for:

C4 / C5 / DS3 / DS4 / DS5
3008 / 5008 / 308 / 508 - 1.6

5F4 / 5FA / 5FC / 5FD / 5FE / 5FF / 5FM / 5FN / 5FR / 5FT
5FV / 5FX / 5FY / 5GF / 5GM / 5GX / 5GY / 5GZ / 5GB / 5GC
5GG / 5GQ / 5GR / 5GW / 5GX / 5GZ / EGX / GCR / GFR

Components:

- x1 catena - chain
- x1 tenditore - tensioner
- x3 pattini/guide - guides
- x2 ingranaggi - gears
- x3 guarnizioni - gasket
- x1 paraolio - oil seal
- x3 viti - screws
- x1 VVT

15 PEZZI - 15 PIECES



Complementary item:

960062 sigillante di tenuta - sealant

Technical information:

Catena semplice [chiusa] - 144 maglie
Bush chain simplex [closed] - 144 links

381614M

Cross Ref:

0816.H4, 0818.27, 0829.E0 [PSA]

Suitable for:

JUMPER / BOXER - 2.2

4HV / 4HG / 4HU / 4HH / 4HJ

Components:

- x1 catena - chain
- x1 tenditore - tensioner
- x3 pattini/guide - guides

5 PEZZI - 5 PIECES



Technical information:

Catena semplice [chiusa] - 122 maglie
Bush chain simplex [closed] - 122 links

Kit catena distribuzione Timing chain kit

Vetture e veicoli commerciali leggeri.
Passenger cars and light commercial vehicles

Adatto a **PSA - PEUGEOT/CITROEN**

Suitable for **PSA - PEUGEOT/CITROEN**

8 PEZZI - 8 PIECES



382835M

Cross Ref:

0831.V9 [PSA]

Suitable for:

JUMPER / BOXER [Euro 5] - 3.0

F30DT / F30DTE / 30DT

Components:

- x1 catena - chain
- x2 tenditore - tensioner
- x2 pattini/guide - guides
- x3 ingranaggi - gears

Technical information:

Catena semplice [chiusa] - 60 maglie
Bush chain simplex [closed] - 60 links

5 PEZZI - 5 PIECES



382980M

Cross Ref:

0831P0 [PSA]

Suitable for:

JUMPER / BOXER [Euro 1/2/3/4] - 3.0

F30DT

Components:

- x1 catena - chain
- x2 pattini/guide - guides
- x2 ingranaggi - gears

Technical information:

Catena duplex [chiusa] - 42 maglie
Bush chain duplex [closed] - 42 links

Suitable for **PSA - PEUGEOT/CITROEN**

Adatto a **PSA - PEUGEOT/CITROEN**

383106M

Cross Ref:

16 348 468 80, 16 163 118 80, 0816.K9 [PSA]

Suitable for:

BIPPER / NEMO - 1.3

FHY / FHZ

Components:

- x1 catena - chain
- x1 tenditore - tensioner
- x2 pattini/guide - guides
- x2 ingranaggi - gears
- x1 guarnizioni - gasket
- x1 paraolio - oil seal
- x9 viti - screws
- x1 ugello olio - oil feed pipe
- x1 flangia - flange

19 PEZZI - 19 PIECES



Technical information:

Catena semplice forata [chiusa] - 120 maglie
Closed simplex chain with lube-hole sleeves - 120 links

383280

Cross Ref:

0816H1, 0816K3, 1611547580 [PSA]

Suitable for:

C1 / 107 / 108 - 1.0

CFA / CFB

Components:

- x1 catena - chain
- x1 tenditore - tensioner
- x2 pattini/guide - guides
- x2 ingranaggi - gears
- x1 paraolio - oil seal

7 PEZZI - 7 PIECES



Technical information:

Catena semplice [chiusa] - 124 maglie
Bush chain simplex [closed] - 124 links

Kit catena distribuzione Timing chain kit

Vetture e veicoli commerciali leggeri.
Passenger cars and light commercial vehicles

Adatto a **PSA - PEUGEOT/CITROEN**

Suitable for **PSA - PEUGEOT/CITROEN**

10 PEZZI - 10 PIECES



Complementary item:

960062 sigillante di tenuta - sealant

Technical information:

Catena semplice [chiusa] - 122 maglie
Bush chain simplex [closed] - 122 links

383320M

Cross Ref:

0816.H4 [PSA]

Suitable for:

JUMPER / BOXER - 2.2

4HG / 4HH / 4HJ / 4HU / 4HV / 4HM

Components:

x1 catena - chain
x1 tenditore - tensioner
x3 pattini/guide - guides
x3 ingranaggi - gears
x1 guarnizioni - gasket
x1 paraolio - oil seal

16 PEZZI - 16 PIECES



Complementary item:

960062 sigillante di tenuta - sealant

Technical information:

Catena semplice [chiusa] - 20 maglie
Bush chain simplex [closed] - 20 links

383580M

Cross Ref:

0816.J1 [PSA]

Suitable for:

BERLINGO / JUMPY / PARTNER / RIFTER - 1.6

8HY / 9HJ / 9HP / 9HS / 9HT / 9HU / 9HT / 9HU / 9HV / 9HW
9HX / 9HY / 9HZ / DV6B

Components:

x1 catena - chain
x1 tenditore - tensioner
x13 guarnizioni - gasket
x1 paraolio - oil seal

Suitable for **PSA - PEUGEOT/CITROEN**

Adatto a **PSA - PEUGEOT/CITROEN**

384060M

Cross Ref:

0816.F6, 0816.F8, 0816.J1 [PSA]

Suitable for:

EXPERT / JUMPY / SPACETOURER / DS4 / C4
[Euro 4/5/6] - 2.0 / 2.2

4HW / 4HX / AHE / AHF / AHG / AHR / AHS / AHU / AHV
AHX / AHY / AHZ / RHC / RHD / RHE / RHF / RHH / RHJ
RHK / RHM / RHR / RHT / RHW / RHX

Components:

x1 catena - chain
x1 tenditore - tensioner
x1 pattini/guide - guides

3 PEZZI - 3 PIECES



Technical information:

Catena semplice [chiusa] - 40 maglie
Bush chain simplex [closed] - 40 links

385678M

Cross Ref:

0816.J2, V8 618 318 80 [PSA]

Suitable for:

BERLINGO / PARTNER - 1.4 / 1.6

5FA / 5FG / 5FH / 5FK / 5FP / 5FS / 5FW / 5FY / 5GB / 5G
5GG / 5GL / 5GM / 5GN / 5GP / 5GQ / 5GR / 5GT / 5GV / 5GX
8FP / 8FR / 8FS / EGX / EP3 / EP3C / EP6 / GCR GFR / GGR

Components:

x1 catena - chain
x1 tenditore - tensioner
x3 pattini/guide - guides
x1 ingranaggi - gears
x7 guarnizioni - gasket
x1 paraolio - oil seal
x26 viti - screws
x2 VVT

42 PEZZI - 42 PIECES



Complementary item:

960062 sigillante di tenuta - sealant

Technical information:

Catena semplice [chiusa] - 138 maglie
Bush chain simplex [closed] - 138 links

Kit catena distribuzione Timing chain kit

Vetture e veicoli commerciali leggeri.
Passenger cars and light commercial vehicles

Adatto a **PSA - PEUGEOT/CITROEN**

Suitable for **PSA - PEUGEOT/CITROEN**

2 PEZZI - 2 PIECES



385708M

Cross Ref:

0816F6 [PSA - PEUGEOT/CITROEN]

Suitable for:

CITROEN JUMPER / C4 - 1.6 / 2.0 / 2.2

AHW (DW10FC) / AHX (DW10FD) / DW12BTED4 / KNBA
KNWA / Q4BA / Q4WA / 224DT / 4HK (DW12MTED4)
4HL (DW12C) / 4HN (DW12MTED4) / 4HP (DW12BTED4)
4HR (DW12BTED4) / 4HS / 4HT / 4HT (DW12BTED4)

Components:

x1 catena - chain
x1 tenditore - tensioner

Technical information:

Catena semplice [chiusa] - 40 maglie
Bush Chain simplex [closed] - 40 links

4 PEZZI - 4 PIECES



385715M

Cross Ref:

0816.G9, 0849.27 [PSA]

Suitable for:

C5 / C6 / 407 / 607 - 2.7 / 3.0

DT17ED4 / DT20C / UHZ / X8C

Components:

x1 catena - chain
x1 tenditore - tensioner
x2 viti - screws

Technical information:

Catena semplice [chiusa] - 44 maglie
Bush chain simplex [closed] - 44 links

Suitable for **PSA - PEUGEOT/CITROEN**

Adatto a **PSA - PEUGEOT/CITROEN**

389746M

Cross Ref:

0816.J1 [PSA]

Suitable for:

JUMPY / BERLINGO / EXPERT / PARTNER / RIFTER - 1.6

8HY / 9HJ / 9HP / 9HS / 9HT / 9HU / 9HT / 9HU / 9HV / 9HW
9HX / 9HY / 9HZ / DV6B

Components:

x1 catena - chain
x1 tenditore - tensioner

2 PEZZI - 2 PIECES



Technical information:

Catena semplice [chiusa] - 20 maglie
Bush chain simplex [closed] - 20 links

902700M

Cross Ref:

103318,103315 [PSA]

Suitable for:

JUMPER / BOXER - 2.2

4HG / 4HH / 4HJ / 4HU / 4HV

Components:

x1 catena - chain
x1 tenditore - tensioner

2 PEZZI - 2 PIECES



Technical information:

Catena semplice [chiusa] - 74 maglie
Bush chain simplex [closed] - 74 links

Adatto a **RENAULT**

Suitable for **RENAULT**

8 PEZZI - 8 PIECES



Technical information:

Catena semplice [chiusa] - 116 maglie
Bush chain simplex [closed] - 116 links

380003M

Cross Ref:

130C17833R [RENAULT]

Suitable for:

MASTER III / ALASKAN - 2.3

M9T 260 / M9T 670 / M9T672 / M9T 676 / M9T 678
M9T 680 / M9T 686 / M9T 690 / M9T 692 / M9T 694
M9T 696 / M9T 698 / M9T 702 / M9T 870 / M9T 872
M9T 876 / M9T 880 / M9T 882 / M9T 890 / M9T 896

Components:

x1 catena - chain
x1 tenditore - tensioner
x2 pattini/guide - guides
x2 ingranaggi - gears
x1 paraolio - oil seal
x1 strumento di montaggio - installation tool

13 PEZZI - 13 PIECES



Complementary item:

960062 sigillante di tenuta - sealant

Technical information:

Catena semplice [chiusa] - 112 maglie
Bush chain simplex [closed] - 112 links

384172M

Cross Ref:

130C11053R, 7701476597, 8200343394 [RENAULT]

Suitable for:

TRAFIC / TALISMAN / SCENIC / MEGANE - 2.0
M9R 610 / M9R 615 / M9R 630 / M9R 650 / M9R 692
M9R 740 / M9R 742 / M9R 744 / M9R 746 / M9R 748
M9R 762 / M9R 763 / M9R 780 / M9R 782 / M9R 786
M9R 800 / M9R 802 / M9R 804 / M9R 805 / M9R 806
M9R 808 / M9R 809 / M9R 812 / M9R 814 / M9R 815
M9R 830 / M9R 832 / M9R 833 / M9R 834 / M9R 835
M9R 849 / M9R 850 / M9R 854 / M9R 855 / M9R 856
M9R 866 / M9R 868

Components:

x1 catena - chain
x1 tenditore - tensioner
x2 pattini/guide - guides
x2 ingranaggi - gears
x6 viti - screws
x1 strumento di montaggio - installation tool

Suitable for **RENAULT**

Adatto a **RENAULT**

384182M

Cross Ref:

7701475740 [RENAULT]

Suitable for:

MASTER II - 3.0

ZD3 200 / ZD3 202

Components:

- x1 catena - chain
- x1 tenditore - tensioner
- x2 pattini/guide - guides
- x2 ingranaggi 26 denti - gears 26 teeth
- x1 paraolio - oil seal



Technical information:

Catena semplice [chiusa] - 82 maglie
Bush chain simplex [closed] - 82 links

384187M

Cross Ref:

130289246R, 130C10990R [RENAULT]

Suitable for:

TRAFIC / TALISMAN / SCENIC / MEGANE - 1.6

R9M 402 / R9M 404 / R9M 408 / R9M 409 / R9M 413
R9M 414 / R9M 415 / R9M 450 / R9M 452 / R9M 453

Components:

- x1 catena - chain
- x1 tenditore - tensioner
- x2 pattini/guide - guides
- x1 ingranaggi - gears
- x1 pignone 38mm - sprocket 38mm



Technical information:

Catena semplice [chiusa] - 106 maglie
Bush chain simplex [closed] - 106 links

Kit catena distribuzione Timing chain kit

Vetture e veicoli commerciali leggeri.
Passenger cars and light commercial vehicles

Adatto a **RENAULT**

Suitable for **RENAULT**

6 PEZZI - 6 PIECES



384210M

Cross Ref:

130C10990R, 130C17602R [RENAULT]

Suitable for:

TRAFIC / TALISMAN / SCENIC / MEGANE - 1.6

R9M 402 / R9M 404 / R9M 408 / R9M 409 / R9M 413
R9M 414 / R9M 415 / R9M 450 / R9M 452 / R9M 453

Components:

x1 catena - chain
x1 tenditore - tensioner
x2 pattini/guide - guides
x1 ingranaggi - gears
x1 pignone 38mm - sprocket 38mm

Technical information:

Catena semplice [chiusa] - 106 maglie
Bush chain simplex [closed] - 106 links

7 PEZZI - 7 PIECES



385811M

Cross Ref:

101096, 130289246R [RENAULT]

Suitable for:

TRAFIC III / ESPACE / MEGANE / SCENIC / TALISMAN - 1.6

R9M 402 / R9M 404 / R9M 408 / R9M 409 / R9M 413
R9M 414 / R9M 415 / R9M 450 / R9M 452 / R9M 453

Components:

x1 catena - chain
x1 tenditore - tensioner
x2 pattini/guide - guides
x2 ingranaggi - gears
x1 strumento di montaggio - installation tool

Complementary item:

960062 sigillante di tenuta - sealant

Technical information:

Catena semplice [chiusa] - 106 maglie
Bush chain simplex [closed] - 106 links

Suitable for **TOYOTA**

Adatto a **TOYOTA**

383280

Cross Ref:

13506-0Q010, 13506-0Q020, 13506-0Q030
13506-21020, 13506-21050, 13506-40010
13506-40020 [TOYOTA]

Suitable for:

AYGO / YARIS / IQ - 1.0

1KR-FE

Components:

x1 catena - chain
x1 tenditore - tensioner
x2 pattini/guide - guides
x2 ingranaggi - gears
x1 paraolio - oil seal



7 PEZZI - 7 PIECES

Technical information:

Catena semplice [chiusa] - 124 maglie
Bush chain simplex [closed] - 124 links

384189M

Cross Ref:

135060R010, 1350626010, 1350626020 [TOYOTA]

Suitable for:

AURIS / AVENSIS / COROLLA / RAV4 / VERSO / IS II
2.0 / 2.2

1AD-FTV / 2AD-FHV / 2AD-FTV

Components:

x1 catena - chain
x1 tenditore - tensioner
x2 pattini/guide - guides
x2 ingranaggi - gears



6 PEZZI - 6 PIECES

Technical information:

Catena semplice [chiusa] - 112 maglie
Bush chain simplex [closed] - 112 links

Kit catena distribuzione Timing chain kit

Vetture e veicoli commerciali leggeri.
Passenger cars and light commercial vehicles

Adatto a **VW - AUDI**

Suitable for **VW - AUDI**

7 PEZZI - 7 PIECES



Complementary item:

960062 sigillante di tenuta - sealant

Technical information:

Catena semplice [chiusa] - 118 maglie
Bush chain simplex [closed] - 118 links

380025M

Cross Ref:

03D109229, 03D109229S2 [VW]

Suitable for:

IBIZA / FABIA / FOX / POLO - 1.2

AWY / BBM / BMD

Components:

x1 catena - chain
x1 tenditore - tensioner
x2 pattini/guide - guides
x2 ingranaggi - gears
x1 paraolio - oil seal

6 PEZZI - 6 PIECES



Technical information:

Catena semplice [chiusa] - 50 maglie
Bush Chain simplex [closed] - 50 links

380026M

Cross Ref:

058109088E, 058109088K [VOLKSWAGEN]

Suitable for:

VOLKSWAGEN GOLF - 1.8

ADR / AEB / AGN / AGU / AJP / AJQ / AMK / ANB / ANQ / APG
APH / APP / APT / APU / APX / AQA / AQE / ARG / ARH / ARK
ARX / ARY / ARZ / ATC / AUM / AUQ / AVC / AVJ / AVV / AWD
AWL / AWP / AWT / AWU / AWV / BAE / BAF / BAM / BBU
BEX / BFB / BFV / BJX / BKB / BKF / BKV / BLZ / BNU / BVP
BVR / CFMA

Components:

x1 catena - chain
x1 tenditore - tensioner
x1 pattini/guide - guides
x3 guarnizioni - gasket

Suitable for **VW - AUDI**

Adatto a **VW - AUDI**

380029M

Cross Ref:

03C 109 158 A [VOLKSWAGEN]

Suitable for:

VOLKSWAGEN TIGUAN / TOURAN - 1.4

BLF / BLP / BTS / BWK / CAVA / CAVB / CAVC / CAVD / CAVE
CAXA / CDDA / CDGA / CFNA / CFNB / CKMA / CLPA / CLPB
CLRA / CMSB / CNKA / CNWA / CTHA / CTHB / CTHC / CTHD
CTHE / CTKA

Components:

x1 catena - chain
x1 tenditore - tensioner
x2 pattini/guide - guides

4 PEZZI - 4 PIECES



Complementary item:

960062 sigillante di tenuta - sealant

Technical information:

Catena dentata [chiusa] - 130 maglie
Tooth chain [closed] - 130 links

380042M

Cross Ref:

06K115225C, 06H115225L, 06H115225N, 06K109158R
06K109158AM, 06K109158BS 06H109158J [VW]

Suitable for:

A3 / A4 / A5 / A6 / Q3 / Q5 / TT / LEON / OCTAVIA
SUPERB / GOLF / PASSAT / TIGUAN - 1.8 / 2.0

BYT / BZB / CABA / CABB / CABD / CAEA / CAEB / CAWB
CCTA / CDNB / CDNC / CDND / CFKA / CJEB / CPMA

Components:

x3 catena - chain
x2 tenditore - tensioner
x7 pattini/guide - guides
x1 ingranaggi - gears

13 PEZZI - 13 PIECES



Technical information:

Catena dentata [chiusa] - 60/96/170 maglie
Tooth chain [closed] - 60/96/170 links

Kit catena distribuzione Timing chain kit

Vetture e veicoli commerciali leggeri.
Passenger cars and light commercial vehicles

Adatto a **VW - AUDI**

Suitable for **VW - AUDI**

14 PEZZI - 14 PIECES



Complementary item:

960062 sigillante di tenuta - sealant

Technical information:

Catena dentata [chiusa] - 130 maglie
Tooth chain [closed] - 130 links

384177M

Cross Ref:

03C109158AC, 03C109158A, 03C109158AQ [VW]

Suitable for:

A1 / A3 / IBIZA / LEON / FABIA / OCTAVIA / SUPERB
YETI / GOLF / PASSAT / POLO / SCIROCCO / TIGUAN
TOURAN - 1.2 / 1.4 / 1.6

BLF / BLP / BTS / BWK / CAVA / CAVB / CAVC / CAVD / CAVE
CKMA / CLPA / CLRA / CMSB / CNKA / CNUB / CNWA / CTHB
CTHC / CTHD / CTHE / CTHF / CTJA / CTJB / CTJC / CTKA

Components:

x1 catena - chain
x1 tenditore - tensioner
x2 pattini/guide - guides
x3 ingranaggi - gears
x1 guarnizioni - gasket
x3 paraolio - oil seal
x2 viti - screws
x1 VVT

8 PEZZI - 8 PIECES



Technical information:

Catena dentata [chiusa] - 130 maglie
Tooth chain [closed] - 130 links

384178M

Cross Ref:

03C109158A [VOLKSWAGEN]

Suitable for:

VOLKSWAGEN GOLF - 1.4

CAVD / CAXA / CDGA

Components:

x1 catena - chain
x1 tenditore - tensioner
x2 pattini/guide - guides
x1 paraolio - oil seal
x3 guarnizioni - gasket

Suitable for **VW - AUDI**

Adatto a **VW - AUDI**

384179M

Cross Ref:

03C109158, 03C109158A [VW]

Suitable for:

A1 / A3 / IBIZA / FABIA / OCTAVIA
GOLF / PASSAT / SCIROCCO / TIGUAN / TOURAN
1.4 / 1.6

BAG / BKG / BLF / BLG / BLN / BMY / BLP / CAVD / CAVE
CAVG / CDGA / CNVA / CNWA / CTHE / CTHG

Components:

x1 catena - chain
x1 tenditore - tensioner
x2 pattini/guide - guides
x1 paraolio - oil seal

5 PEZZI - 5 PIECES



Complementary item:

960062 sigillante di tenuta - sealant

Technical information:

Catena dentata [chiusa] - 130 maglie
Tooth chain [closed] - 130 links

384180M

Cross Ref:

03C109158A, 03C109158B, 03C109158 [VW]

Suitable for:

IBIZA / FABIA / RAPID / POLO / GOLF - 1.2

BXV / BZG / CGPA / CGPB / CGPC

Components:

x1 catena - chain
x1 tenditore - tensioner
x2 pattini/guide - guides
x3 ingranaggi - gears
x1 paraolio - oil seal

8 PEZZI - 8 PIECES



Complementary item:

960062 sigillante di tenuta - sealant

Technical information:

Catena dentata [chiusa] - 130 maglie
Tooth chain [closed] - 130 links

Kit catena distribuzione Timing chain kit

Vetture e veicoli commerciali leggeri.
Passenger cars and light commercial vehicles

Adatto a **VW - AUDI**

Suitable for **VW - AUDI**

13 PEZZI - 13 PIECES

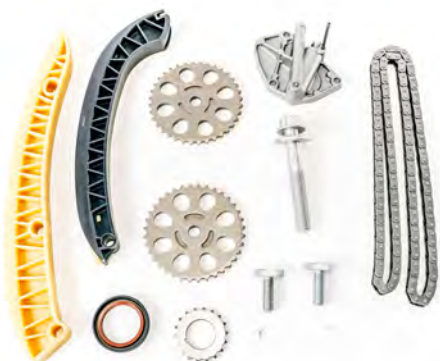

Complementary item:

960062 sigillante di tenuta - sealant

Technical information:

Catena semplice [chiusa] - 130 maglie
Bush chain simplex [closed] - 130 links

384181M

Cross Ref:

03E109229A [VW]

Suitable for:

IBIZA / FABIA / POLO - 1.2

AZQ / BME / BXV / BZG / CEVA

Components:

x1 catena - chain
x1 tenditore - tensioner
x2 pattini/guide - guides
x3 ingranaggi - gears
x1 paraolio - oil seal
x3 viti - screws
x2 rondelle - washers

18 PEZZI - 18 PIECES



Technical information:

Catena dentata [chiusa] - 60/96/170 maglie
Tooth chain [closed] - 60/96/170 links

385015M

Cross Ref:

06K109158BE [VOLKSWAGEN]

Suitable for:

VOLKSWAGEN GOLF - 1.8 / 2.0

CJXB / CJXC / CJXE / CJXG / DAJA / DAJB

Components:

x3 catena - chain
x2 tenditore - tensioner
x7 pattini/guide - guides
x2 ingranaggi - gears
x1 paraolio - oil seal
x3 guarnizioni - gasket

Suitable for **VW - AUDI**

Adatto a **VW - AUDI**

385025M

Cross Ref:

06K109158BS [VOLKSWAGEN]

Suitable for:

VOLKSWAGEN GOLF - 1.8 / 2.0

CJXB / CJXC / CJXD / CJXE / CJXG
DAJA / DAJB / DJHA / DJHB / DLBA

Components:

x3 catena - chain
x2 tenditore - tensioner
x7 pattini/guide - guides
x2 ingranaggi - gears

14 PEZZI - 14 PIECES



Technical information:

Catena dentata [chiusa] - 60/96/170 maglie
Tooth chain [closed] - 60/96/170 links

385612M

Cross Ref:

03F 109 158 K [AUDI]

Suitable for:

AUDI A1 - 1.2 TFSI

CBZA / CBZB

Components:

x1 catena - chain
x1 tenditore - tensioner
x2 pattini/guide - guides
x1 ingranaggi - gears
x1 paraolio - oil seal
x1 vite - screw

7 PEZZI - 7 PIECES



Technical information:

Catena dentata [chiusa] - 150 maglie
Tooth chain [closed] - 150 links

Kit catena distribuzione Timing chain kit

Vetture e veicoli commerciali leggeri.
Passenger cars and light commercial vehicles

Adatto a **VW - AUDI**

Suitable for **VW - AUDI**

7 PEZZI - 7 PIECES



Complementary item:

960062 sigillante di tenuta - sealant

Technical information:

Catena dentata [chiusa] - 150 maglie
Tooth chain [closed] - 150 links

385613M

Cross Ref:

03F109158G, 03F198229B [VW]

Suitable for:

A1 / A3 / IBIZA / LEON / FABIA / OCTAVIA / RAPID
CADDY / GOLF / POLO / TOURAN - 1.2

CBZA / CBZB / CBZC

Components:

x1 catena - chain
x1 tenditore - tensioner
x2 pattini/guide - guides
x1 ingranaggi - gears
x1 paraolio - oil seal
x1 viti - screws

13 PEZZI - 13 PIECES



Technical information:

Catena dentata [chiusa] - 60/96/170 maglie
Tooth chain [closed] - 60/96/170 links

385616M

Cross Ref:

06H109469AN, 06H115225L, 06H115225N, 06H115225A
06K109158A, 06K109158B, 06K109158R [VW]

Suitable for:

A3 / A4 / A5 / A6 / Q5 / TT / LEON / OCTAVIA / SUPERB
YETI / AMAROK / GOLF / PASSAT / SCIROCCO
TIGUAN - 1.8 / 2.0

CAEA / CAEB / CAWB / CBFA / CCTA / CCZA / CCZB / CCZD
CDAA / CDAB / CDNB / CDNC / CFKA / CPMA

Components:

x3 catena - chain
x2 tenditore - tensioner
x6 pattini/guide - guides
x2 ingranaggi - gears

Suitable for **VW - AUDI**

Adatto a **VW - AUDI**

385843M

Cross Ref:

06K 109 158 AD [VOLKSWAGEN]

Suitable for:

VOLKSWAGEN - 2.0

BWA / CCZA

Components:

- x2 catena - chain
- x2 tenditore - tensioner
- x6 pattini/guide - guides
- x2 ingranaggi - gears
- x1 paraolio - oil seal

13 PEZZI - 13 PIECES



Technical information:

Catena dentata [chiusa] - 96/170 maglie
Tooth chain [closed] - 96/170 links

385875M

Cross Ref:

03C109158A [VOLKSWAGEN]

Suitable for:

VOLKSWAGEN TIGUAIN - 1.4

BWK / CAVA / CTHA

Components:

- x1 catena - chain
- x1 tenditore - tensioner
- x2 pattini/guide - guides
- x3 ingranaggi - gears
- x2 viti - screws
- x1 paraolio - oil seal

10 PEZZI - 10 PIECES



Technical information:

Catena dentata [chiusa] - 130 maglie
Tooth chain [closed] - 130 links

Kit catena distribuzione Timing chain kit

Vetture e veicoli commerciali leggeri.
Passenger cars and light commercial vehicles

Adatto a **VOLVO**

Suitable for **VOLVO**

16 PEZZI - 16 PIECES



Complementary item:

960062 sigillante di tenuta - sealant

Technical information:

Catena semplice [chiusa] - 20 maglie
Bush chain simplex [closed] - 20 links

383580M

Cross Ref:

8653755 [VOLVO]

Suitable for:

C30 / S40 / S80 / V50 / V70 - 1.6

D4164T

Components:

x1 catena - chain
x1 tenditore - tensioner
x13 guarnizioni - gasket
x1 paraolio - oil seal

3 PEZZI - 3 PIECES



Technical information:

Catena semplice [chiusa] - 40 maglie
Bush chain simplex [closed] - 40 links

384060M

Cross Ref:

8653755, 30725030 [VOLVO]

Suitable for:

C30 / C70 / S40 / S80 / V50 / V70
[Euro 4/5/6] - 2.0

D4204T / D4204T2

Components:

x1 catena - chain
x1 tenditore - tensioner
x1 pattini/guide - guides



Ordine crescente per codice OE
Ascending order by OE code

Per applicazione vettura e veicoli commerciali leggeri
Suitable for passenger cars and LCV applications.

Car maker	OE component	Code Mec	Pg.
ALFA ROMEO	46788783	383216M	.33
ALFA ROMEO	5636444	383105M	.33
BMW - MINI	11310150552	380046M	.35
BMW - MINI	11310150552	385678M	.40
BMW - MINI	11311439853	380046M	.35
BMW - MINI	11311439853	385678M	.40
BMW - MINI	11312249851	380015M	.34
BMW - MINI	11317516088	380031M	.34
BMW - MINI	11317516088	380047M	.36
BMW - MINI	11317534784	380031M	.34
BMW - MINI	11317534784	380047M	.36
BMW - MINI	11317797897	380043M	.35
BMW - MINI	11317797897	384192M	.38
BMW - MINI	11317797902	384192M	.38
BMW - MINI	11318506650	380685M	.37
BMW - MINI	11318506652	384192M	.38
BMW - MINI	11318506869	380015M	.34
BMW - MINI	11318570649	380683M	.36
BMW - MINI	11318570649	384192M	.38
BMW - MINI	11318570649	384198M	.38
BMW - MINI	11318570649	385085M	.39
BMW - MINI	11318572503	380830M	.37
BMW - MINI	11318618317	380031M	.34
BMW - MINI	11318618317	380047M	.36
BMW - MINI	11318618318	380046M	.35

Car maker	OE component	Code Mec	Pg.
BMW - MINI	11318618318	385678M	.40
BMW - MINI	11318648729	384975M	.39
BMW - MINI	11417797896	380683M	.36
BMW - MINI	11417797896	384198M	.38
BMW - MINI	13522249852	380015M	.34
BMW - MINI	13527789690	380015M	.34
BMW - MINI	13527797906	380683M	.36
BMW - MINI	13528490224	384198M	.38
BMW - MINI	13528506969	380015M	.34
BMW - MINI	13528572504	384192M	.38
BMW - MINI	13528575471	384192M	.38
BMW - MINI	13528576284	384198M	.38
BMW - MINI	13528589971	380683M	.36
BMW - MINI	13529886258	380683M	.36
BMW - MINI	13529886258	384192M	.38
DAIHATSU	13506-B1010	380024	.41
FIAT	1231280	383580M	.49
FIAT	1231282	383580M	.49
FIAT	46788783	383105M	.45
FIAT	46788783	383107	.46
FIAT	504013619	946411	.52
FIAT	504161356	382980M	.44
FIAT	504161356	383300	.47
FIAT	504288857	382830M	.47
FIAT	504288857	383300	.43

Car maker	OE component	Code Mec	Pg.
FIAT	504294672	382995M	.45
FIAT	504310252	383500	.48
FIAT	55171579	383105M	.45
FIAT	55171579	383107	.46
FIAT	55195293	383216M	.47
FIAT	55205448	383216M	.47
FIAT	55225494	384193M	.50
FIAT	55258509	384193M	.50
FIAT	55261264	383106M	.46
FIAT	55261264	383107	.46
FIAT	55267975	381116M	.42
FIAT	55283520	383105M	.45
FIAT	55283520	383106M	.46
FIAT	5801375558	382835M	.44
FIAT	5801375558	383500	.48
FIAT	5802009661	382980M	.44
FIAT	5802122595	383503M	.49
FIAT	6000620371	387160M	.51
FIAT	71739327	380067M	.42
FIAT	71742008	385723M	.51
FIAT	71776647	383216M	.47
FIAT	71777824	383105M	.45
FIAT	71777824	383106M	.46
FIAT	71777824	383107	.46
FIAT	9400849229	384060M	.50

Car maker	OE component	Code Mec	Pg.
FIAT	9464474289	384060M	.50
FIAT	965937118	902700M	.52
FIAT	9659438580	381614M	.43
FIAT	9659438580	383320M	.48
FIAT	9659486680	381614M	.43
FIAT	9675827980	902700M	.52
FORD	1102609	383390M	.55
FORD	1102609	384960M	.58
FORD	1198056	380036M	.53
FORD	1221119	383390M	.55
FORD	1231280	383580M	.56
FORD	1231282	383580M	.56
FORD	1231282	384060M	.56
FORD	1231971	384060M	.56
FORD	1235939	902700M	.59
FORD	1253958	383390M	.55
FORD	1372438	381614M	.54
FORD	1372841	384120M	.57
FORD	1448169	389746M	.58
FORD	1704049	381607M	.54
FORD	1704066	381607M	.54
FORD	1704067	381614M	.54
FORD	1704087	381614M	.54
FORD	1704089	380041M	.53
FORD	1704089	381607M	.54

Car maker	OE component	Code Mec	Pg.
FORD	1704089	384120M	.57
FORD	1704089	384184M	.57
FORD	6C1Q-6268-BB	383320M	.55
FORD	6C1Q-6268-BB	384120M	.57
HYUNDAI - KIA	233514A020	384194M	.60
HYUNDAI - KIA	233514A600	384194M	.60
HYUNDAI - KIA	233514A700	384194M	.60
HYUNDAI - KIA	243512A000	384140M	.60
HYUNDAI - KIA	243512A001	384140M	.60
HYUNDAI - KIA	243514A020	384194M	.60
HYUNDAI - KIA	243612A000	384140M	.60
HYUNDAI - KIA	243612A001	384140M	.60
HYUNDAI - KIA	243612F000	384194M	.60
HYUNDAI - KIA	243614A000	384140M	.60
HYUNDAI - KIA	243614A020	384194M	.60
HYUNDAI / KIA	24351-2A001	385385M	.61
HYUNDAI / KIA	24351-2F000	385135M	.61
IVECO	504068388	946411	.65
IVECO	504084527	383300	.64
IVECO	504084528	383300	.64
IVECO	504091968	382980M	.63
IVECO	504294672	383500	.64
IVECO	5801375562	383300	.64
IVECO	5801514998	382830M	.62
IVECO	5801628694	382835M	.62

Car maker	OE component	Code Mec	Pg.
IVECO	5801628694	383500	.64
IVECO	5802009617	382835M	.62
IVECO	5802009617	383500	.64
IVECO	5802009618	382830M	.62
IVECO	5802009618	383300	.64
IVECO	5802009660	382995M	.63
IVECO	5802009661	383300	.64
IVECO	5802122595	383503M	.65
IVECO	5802335733	382830M	.62
IVECO	5802335733	383300	.64
LAND ROVER	1316113	385715M	.67
LAND ROVER	LR004405S1	902700M	.68
LAND ROVER	LR004406S1	902700M	.68
LAND ROVER	LR004457	384120M	.66
LAND ROVER	LR019664S1	902700M	.68
LAND ROVER	LR023524	384120M	.66
LAND ROVER	LR132676	381980M	.66
LAND ROVER	LR132676	384660M	.67
MERCEDES - SMART	1600500211	383200M	.70
MERCEDES - SMART	1609970294	383202M	.71
MERCEDES - SMART	1609970494	383200M	.70
MERCEDES - SMART	1609970494	383202M	.71
MERCEDES - SMART	1609970494S5	383200M	.70
MERCEDES - SMART	1609970594	383202M	.71
MERCEDES - SMART	6609970094	383251M	.71

Car maker	OE component	Code Mec	Pg.
MERCEDES - SMART	A0003953V00100000	383251M	.71
MERCEDES - SMART	A0009933502	384800M	.72
MERCEDES - SMART	A0009933502	385305M	.72
MERCEDES - SMART	A0009933502	385748M	.73
MERCEDES - SMART	A0009934676	385748M	.73
MERCEDES - SMART	A0009934676	385755M	.73
MERCEDES - SMART	A0009936176	385748M	.73
MERCEDES - SMART	A0009936176	385755M	.73
MERCEDES - SMART	A0009936276	380022M	.69
MERCEDES - SMART	A0009936276	380023M	.70
MERCEDES - SMART	A0009936276	385748M	.73
MERCEDES - SMART	A0009936276	385755M	.73
MERCEDES - SMART	A0009938276	385748M	.73
MERCEDES - SMART	A0029973394S1	385769M	.74
MERCEDES - SMART	A0039972094S1	385769M	.74
MERCEDES - SMART	A0039977594	380002M	.69
MERCEDES - SMART	A1600500369	383202M	.71
MERCEDES - SMART	A39974294	385769M	.74
MERCEDES - SMART	A5080209AA	380002M	.69
NISSAN	-	385811M	.80
NISSAN	1302800Q0A	384172M	.77
NISSAN	1302800Q0E	384172M	.77
NISSAN	1302800Q0M	384210M	.78
NISSAN	1302800Q1D	384187M	.78
NISSAN	1302800Q1D	384210M	.78

Car maker	OE component	Code Mec	Pg.
NISSAN	13028-00QAA	384182M	.77
NISSAN	13028-2W200	384182M	.77
NISSAN	13028AD202	380038M	.75
NISSAN	13028AD202	380039M	.76
NISSAN	13028AD20A	385800M	.79
NISSAN	13028AD211	380038M	.75
NISSAN	13028AD211	380039M	.76
NISSAN	13028AD211	384110M	.76
NISSAN	13028AD212	380038M	.75
NISSAN	13028AD212	380039M	.76
NISSAN	13028AD212	384110M	.76
NISSAN	13028AW410	380038M	.75
NISSAN	13028AW410	380039M	.76
NISSAN	13028AW410	384110M	.76
NISSAN	13028EB300	384110M	.76
NISSAN	13028-EB70A	385805M	.79
NISSAN	13028-EB70B	385805M	.79
NISSAN	130C17833R	380003M	.75
NISSAN	1351000Q0A	384187M	.78
OPEL	-	383116M	.84
OPEL	-	385811M	.88
OPEL	130C17833R	380003M	.81
OPEL	4415559	384182M	.86
OPEL	4423571	384210M	.87
OPEL	4431143	384187M	.87

Car maker	OE component	Code Mec	Pg.
OPEL	4452569	384172M	.86
OPEL	46804589	383105M	.83
OPEL	46804589	383106M	.83
OPEL	46804589	383107	.84
OPEL	55221385	383105M	.83
OPEL	55221385	383106M	.83
OPEL	55221385	383107	.84
OPEL	55562222	385704M	.88
OPEL	55562234	380037M	.81
OPEL	55562234	380044M	.82
OPEL	55562234	383212	.85
OPEL	55562234	385704M	.88
OPEL	5636360	385704M	.88
OPEL	5636444	383216M	.85
OPEL	637241	385704M	.88
OPEL	646139	381960M	.82
OPEL	6606022	383212	.85
OPEL	90529570	383212	.85
OPEL	90529570	385704M	.88
OPEL	93161608	384187M	.87
OPEL	93161656	384172M	.86
OPEL	93177407	383216M	.85
OPEL	93198847	384172M	.86
OPEL	95522267	385704M	.88
PIAGGIO	B010097	380695	.89

Car maker	OE component	Code Mec	Pg.
PIAGGIO	B010098	380695	.89
PIAGGIO	B010107	380695	.89
PIAGGIO	B010109	380695	.89
PSA	0816.F6	384060M	.95
PSA	0816.F8	384060M	.95
PSA	0816.G9	385715M	.96
PSA	0816.H4	381614M	.91
PSA	0816.H4	383320M	.94
PSA	0816.J1	383580M	.94
PSA	0816.J1	384060M	.95
PSA	0816.J1	389746M	.97
PSA	0816.J2	380046M	.90
PSA	0816.J2	385678M	.95
PSA	0816.K9	383106M	.93
PSA	0816F6	385708M	.96
PSA	0816H1	383280	.93
PSA	0816H9	380031M	.90
PSA	0816H9	380047M	.91
PSA	0816K3	383280	.93
PSA	0818.27	381614M	.91
PSA	0829.E0	381614M	.91
PSA	0831.V9	382835M	.92
PSA	0831P0	382980M	.92
PSA	0849.27	385715M	.96
PSA	103315	902700M	.97

Car maker	OE component	Code Mec	Pg.
PSA	103318	902700M	.97
PSA	16 163 118 80	383106M	.93
PSA	16 348 468 80	383106M	.93
PSA	1611547580	383280	.93
PSA	98 228 271 80	380031M	.90
PSA	98 228 271 80	380047M	.91
PSA	V8 618 318 80	380046M	.90
PSA	V8 618 318 80	385678M	.95
PSA	V861831780	380031M	.90
PSA	V861831780	380047M	.91
RENAULT	101096	385811M	.100
RENAULT	130289246R	384187M	.99
RENAULT	130289246R	385811M	.100
RENAULT	130C10990R	384187M	.99
RENAULT	130C10990R	384210M	.100
RENAULT	130C11053R	384172M	.98
RENAULT	130C17602R	384210M	.100
RENAULT	130C17833R	380003M	.98
RENAULT	7701475740	384182M	.99
RENAULT	7701476597	384172M	.98
RENAULT	8200343394	384172M	.98
TOYOTA	13506-0Q010	383280	.101
TOYOTA	13506-0Q020	383280	.101
TOYOTA	13506-0Q030	383280	.101
TOYOTA	135060R010	384189M	.101

Car maker	OE component	Code Mec	Pg.
TOYOTA	13506-21020	383280	.101
TOYOTA	13506-21050	383280	.101
TOYOTA	1350626010	384189M	.101
TOYOTA	1350626020	384189M	.101
TOYOTA	13506-40010	383280	.101
TOYOTA	13506-40020	383280	.101
VOLKSWAGEN - AUDI	03C 109 158 A	380029M	.103
VOLKSWAGEN - AUDI	03C109158	384179M	.105
VOLKSWAGEN - AUDI	03C109158	384180M	.105
VOLKSWAGEN - AUDI	03C109158A	384177M	.104
VOLKSWAGEN - AUDI	03C109158A	384178M	.104
VOLKSWAGEN - AUDI	03C109158A	384179M	.105
VOLKSWAGEN - AUDI	03C109158A	384180M	.105
VOLKSWAGEN - AUDI	03C109158A	385875M	.109
VOLKSWAGEN - AUDI	03C109158AC	384177M	.104
VOLKSWAGEN - AUDI	03C109158AQ	384177M	.104
VOLKSWAGEN - AUDI	03C109158AR	384177M	.104
VOLKSWAGEN - AUDI	03C109158B	384180M	.105
VOLKSWAGEN - AUDI	03D109229	380025M	.102
VOLKSWAGEN - AUDI	03D109229S2	380025M	.102
VOLKSWAGEN - AUDI	03E109229A	384181M	.106
VOLKSWAGEN - AUDI	03F 109 158 K	385612M	.107
VOLKSWAGEN - AUDI	03F109158G	385613M	.108
VOLKSWAGEN - AUDI	03F198229B	385613M	.108
VOLKSWAGEN - AUDI	058109088E	380026M	.102

Car maker	OE component	Code Mec	Pg.
VOLKSWAGEN - AUDI	058109088K	380026M	.102
VOLKSWAGEN - AUDI	06H109158J	380042M	.103
VOLKSWAGEN - AUDI	06H109469AN	385616M	.108
VOLKSWAGEN - AUDI	06H115225A	385616M	.108
VOLKSWAGEN - AUDI	06H115225L	380042M	.103
VOLKSWAGEN - AUDI	06H115225L	385616M	.108
VOLKSWAGEN - AUDI	06H115225N	380042M	.103
VOLKSWAGEN - AUDI	06H115225N	385616M	.108
VOLKSWAGEN - AUDI	06K 109 158 AD	385843M	.109
VOLKSWAGEN - AUDI	06K109158A	385616M	.108
VOLKSWAGEN - AUDI	06K109158AD	385616M	.108
VOLKSWAGEN - AUDI	06K109158AM	380042M	.103
VOLKSWAGEN - AUDI	06K109158B	385616M	.108
VOLKSWAGEN - AUDI	06K109158BE	385015M	.106
VOLKSWAGEN - AUDI	06K109158BS	380042M	.103
VOLKSWAGEN - AUDI	06K109158BS	385025M	.107
VOLKSWAGEN - AUDI	06K109158R	380042M	.103
VOLKSWAGEN - AUDI	06K109158R	385616M	.108
VOLKSWAGEN - AUDI	06K115225C	380042M	.103
VOLVO	30725030	384060M	.110
VOLVO	8653755	383580M	.110
VOLVO	8653755	384060M	.110

**Dubhe è un distributore esclusivo
di kit catena a marchio Mec-Diesel.**



**Dubhe is an exclusive distributor
of Mec-Diesel branded timing kit.**

La costante ricerca dei migliori prodotti sul mercato e l'elevata competenza tecnica ci hanno permesso di realizzare un catalogo interamente dedicato alle componenti coinvolte nella manutenzione straordinaria del veicolo.

Trova facilmente il kit catena Mec-Diesel grazie alla ricerca per applicazione e per codice OEM.

Our technical expertise and the ongoing research of the best possible product have led to the development of a catalogue entirely focused on components involved in the extraordinary maintenance of the vehicle. Find now your Mec-Diesel timing chain kit with search by application and OEM references.

Distributore ufficiale in Italia

Dubhe S.r.l.
Via Sestriere, 3 - 10060 Candiolo (TO) - Italy
+39 011 397.21.32
sales@dubhegroup.com

Official distributor abroad

Dubhe S.r.l.
Via Sestriere, 3 - 10060 Candiolo (TO) - Italy
+39 011 397.21.32
export@dubhegroup.com



Dubhe S.r.l.
E-commerce



Mec-Diesel è un marchio distribuito da Dubhe Srl
Mec-Diesel is a brand distributed by Dubhe Srl